

NF3000C-YXZ Series (RoHS认证产品)

三相三线式 500VAC

省空間书状型

中性点接地電源用



UL1283 (file No.E102708)
EN60939-2 (file No.R50031207)

用途

半导体制造装置、大型机床、通用逆变器、伺服等的应用装置、CVCF等的电源装置、电梯电源、工厂电源等

规格

Part No.	Rated Current	Weight	Dimensions [mm]											fig1
			A	B	C	D	E	F	G	H	J	K	L	
NF3010C-YXZ	10A	0.5kg	110	100	50	40	95	M4	M4	M4	R2.25x6	dia.4.5	9	11
NF3020C-YXZ	20A													
NF3030C-YXZ	30A													
NF3040C-YXZ	40A	0.8kg	128	120	65	55	95	M5	M5	M4	R2.25x6	dia.4.5	13	16
NF3050C-YXZ	50A													
NF3060C-YXZ	60A													
NF3080C-YXZ	80A	1.6kg	fig2											
NF3100C-YXZ	100A	2.8kg	fig3											
NF3125C-YXZ	125A													
NF3150C-YXZ	150A													
NF3200C-YXZ	200A	6.9kg	fig4											
NF3250C-YXZ	250A	8.1kg												
NF3300C-YXZ	300A													
Rated Voltage	500VAC max													
Leakage Current	100mA max 400VAC 50Hz By UL1283													
Ambient temp.	-20 up to 50 Deg.C													

fig.1 (10~60A)

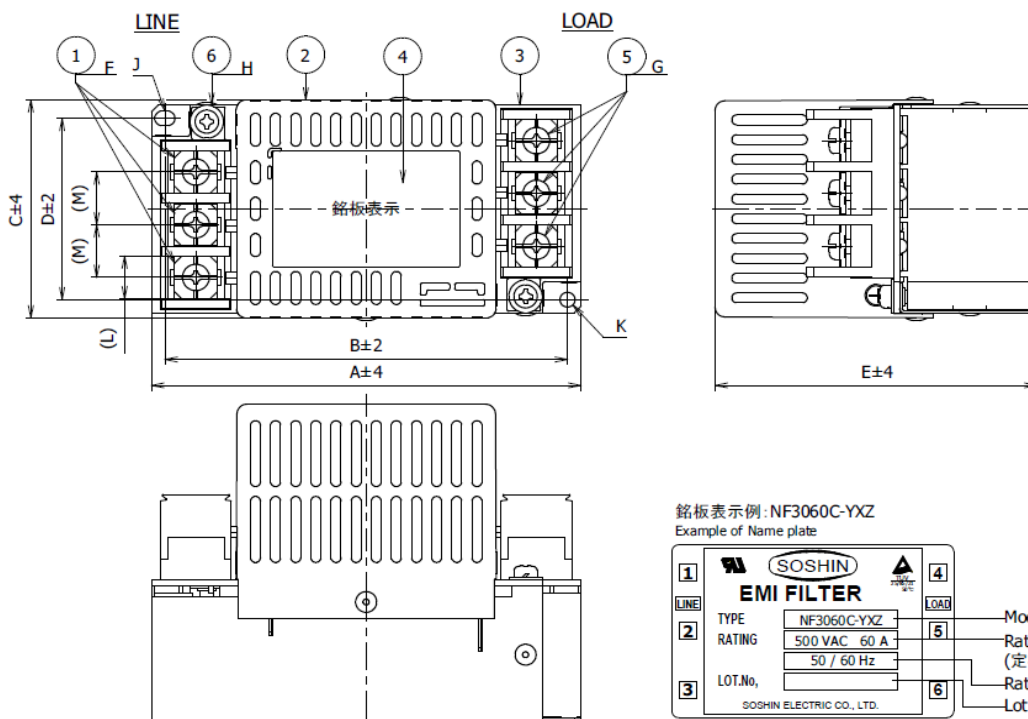

fig.2 (80, 100A)

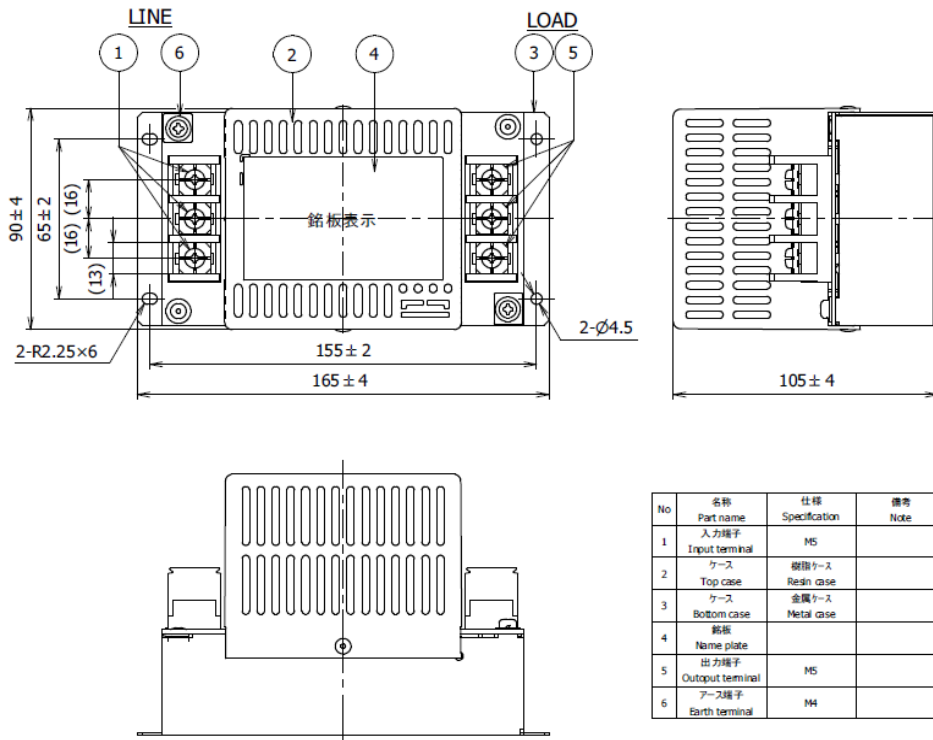

fig. 3 (125, 150)

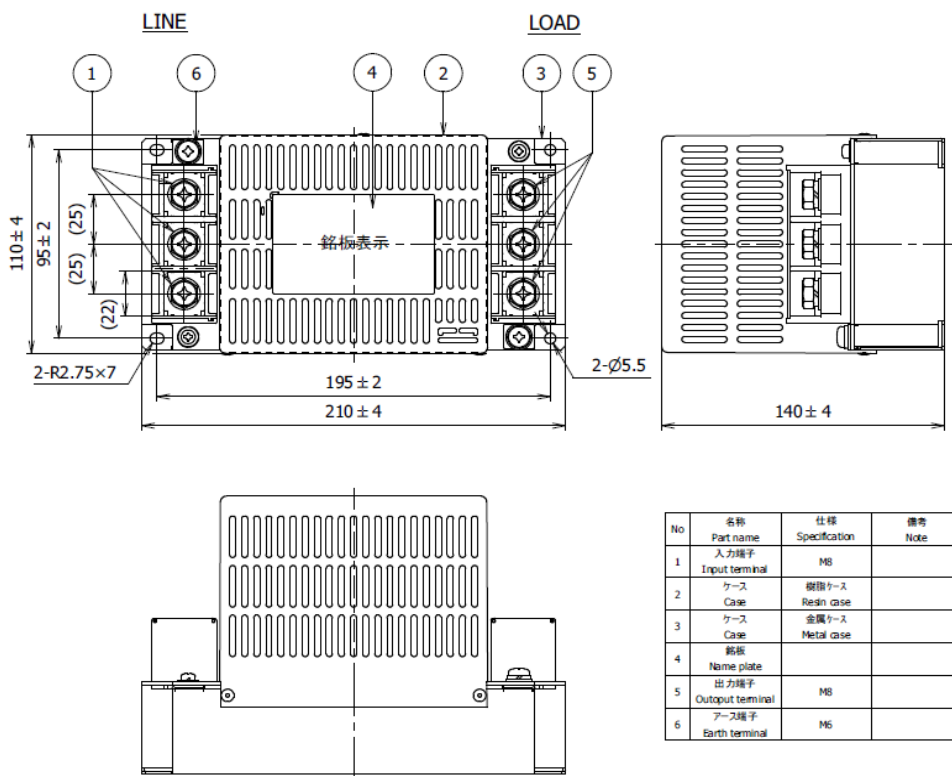
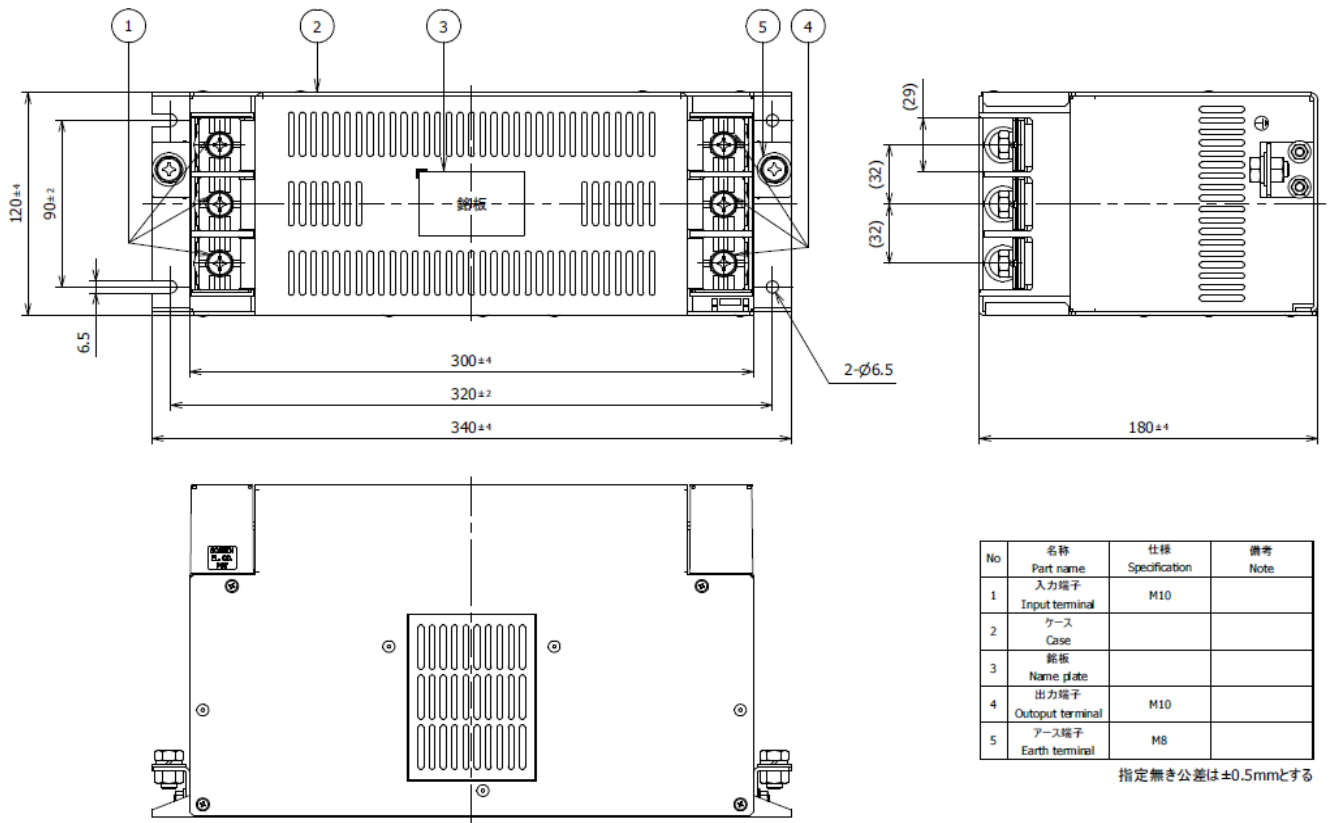
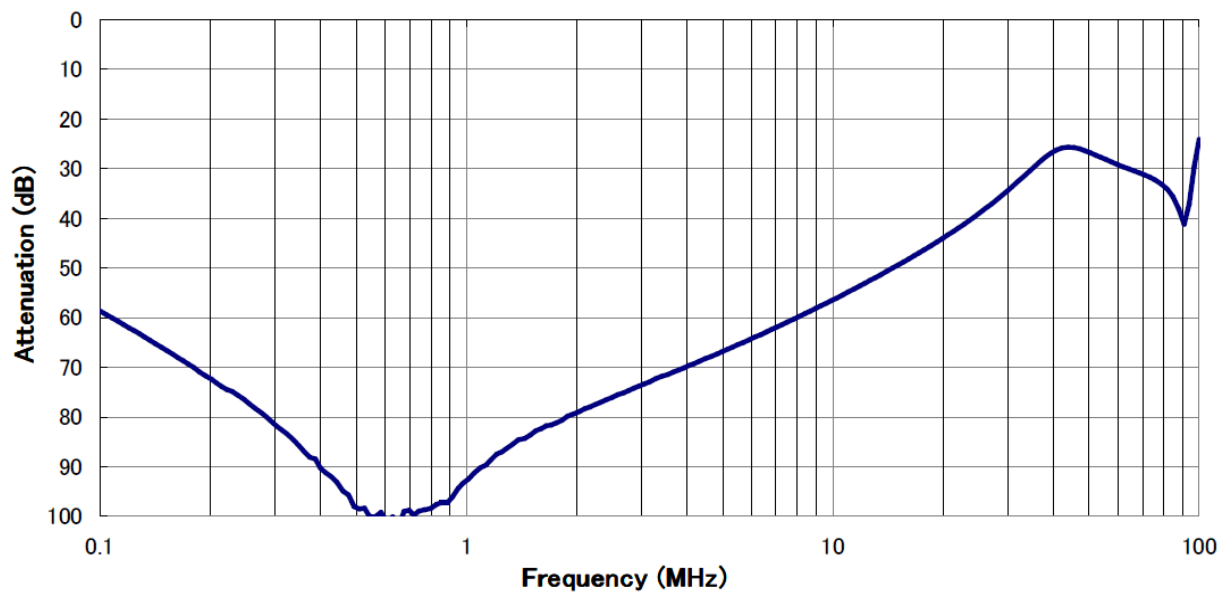

fig. 4 (200~300A)



代表特性 (10, 20, 30A)



代表特性 (40, 50, 60A)

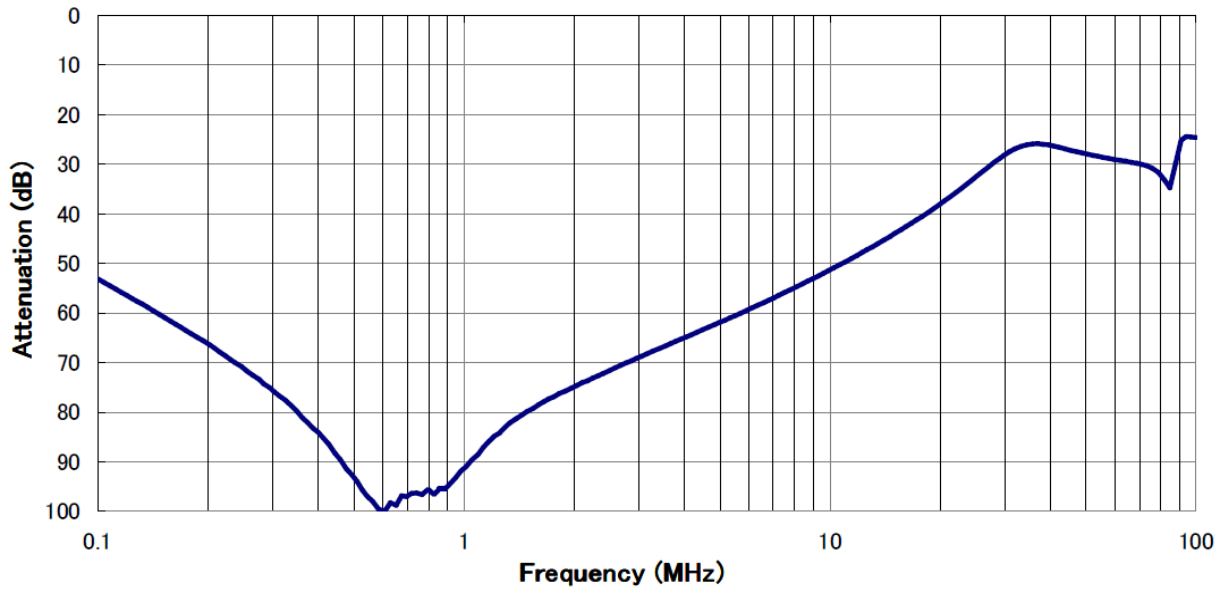

代表特性 (80, 100A)

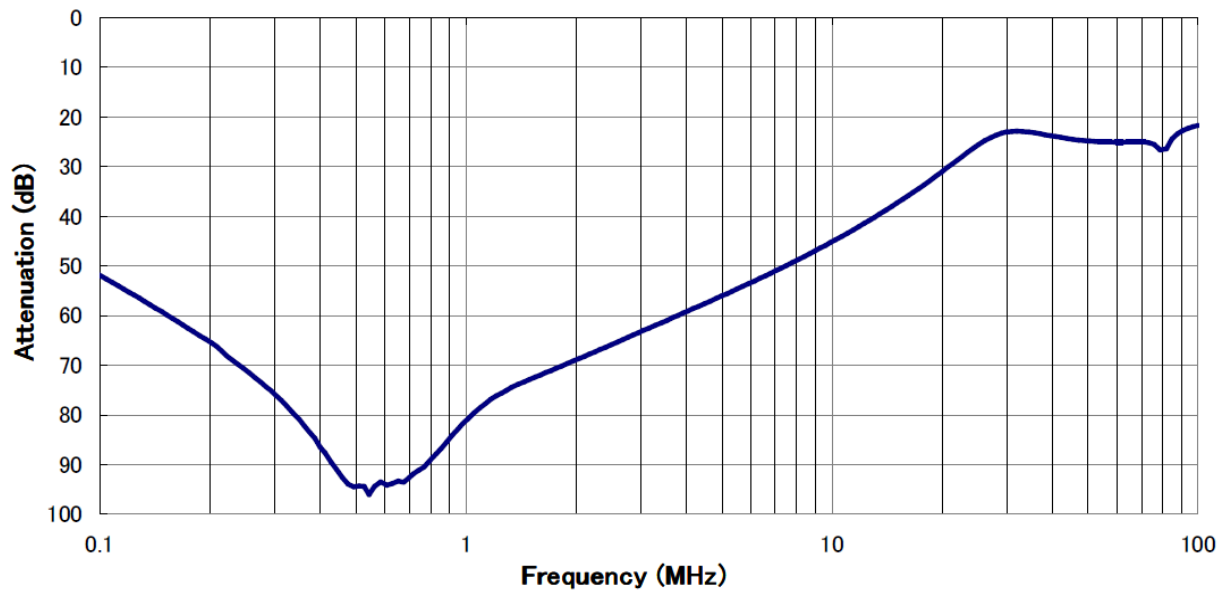

代表特性 (125, 150A)

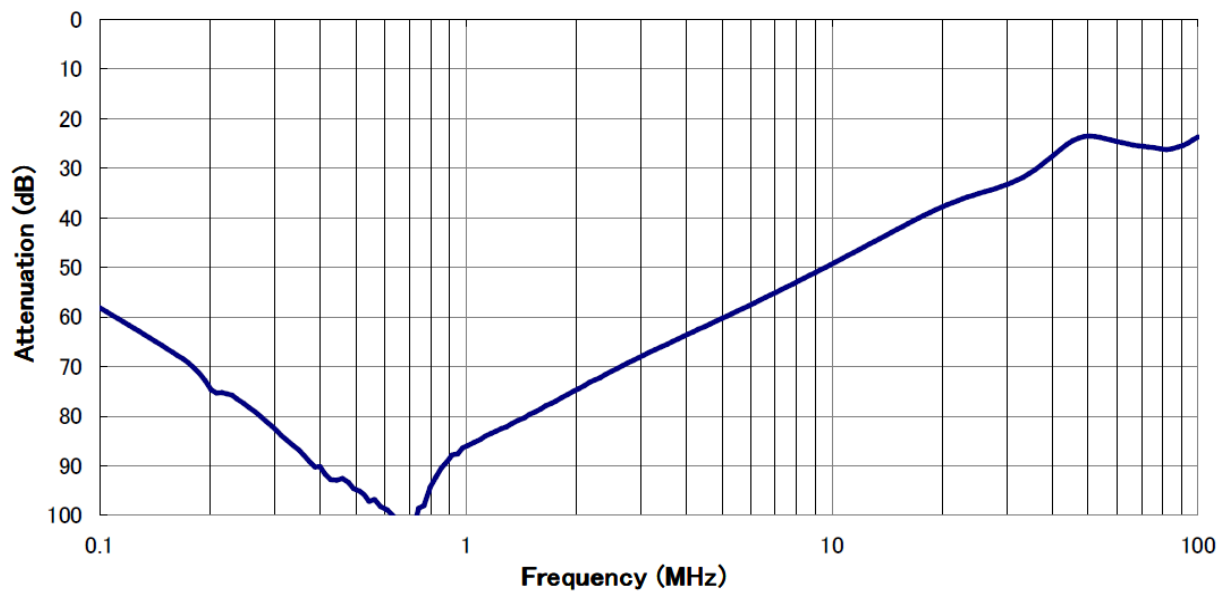

回路图

