

Product Information

Control No. : ARP-4910300-G 1

Issued on April 13, 2020

Application : 2.0GHz LPF

1. Type No.

HMD9103D-T

RoHS Compliant Part

2. Dimension (Unit : mm)

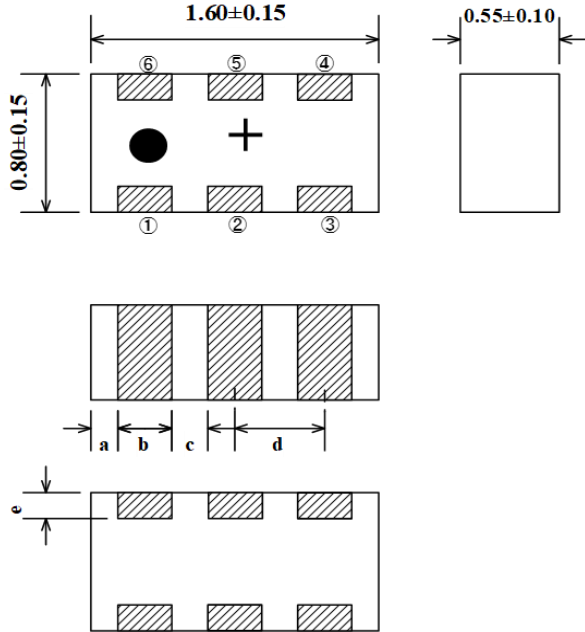

Terminal	
①	GND
②	Input
③	GND
④	GND
⑤	Output
⑥	GND

Terminal Dimensions	
a	0.15 +/- 0.15
b	0.30 +/- 0.10
c	0.20 +/- 0.10
d	0.50 +/- 0.10
e	0.15 +/- 0.10

3. Electrical characteristics

Pass band	Specification	Typical	Unit
fc (Center frequency)	1726.45	-	MHz
Pass band frequency	1427.9-2025	-	MHz
Nominal impedance	50	-	ohm
Insertion Loss in 1427.9~2025MHz at 25degC.	0.5 Max.	0.30	dB
Insertion Loss in 1427.9~2025MHz at -40 to +105degC.	0.7 Max.	0.50	dB
Return Loss in 1427.9~2025	16.0 Min.	18.6	dB
Ripple	0.40 Max.	0.12	dB

Attenuation	Specification	Typical	Unit
4428.12 MHz - 4450 MHz	20 Min.	48.38	dB
4450 MHz - 4900 MHz	35 Min.	49.40	dB
4900 MHz - 5925 MHz	40 Min.	49.10	dB
5925 MHz - 12750 MHz	25 Min.	27.54	dB

IIP3	Specification	Typical	Unit
1427.9 MHz - 2025 MHz	45 Min.	49.61	dBm

4. Note

4.1 Operating Temperature Range

4.2 Storage Temperature Range

4.3 Standard Reel Quantity

: -40 to +105 deg C.

: -40 to +85 deg C. (goods alone)

: -20 to +35 deg C. (In a Taping Package)

: 3,000 pcs (per reel, per bag)

Approved by	Confirmed by	Raised by
Y.Mizutani	Y.Imai	G.Nishio

SOSHIN ELECTRIC CO., LTD

5.Representative characteristics

Measured

Pass Band Frequency Response

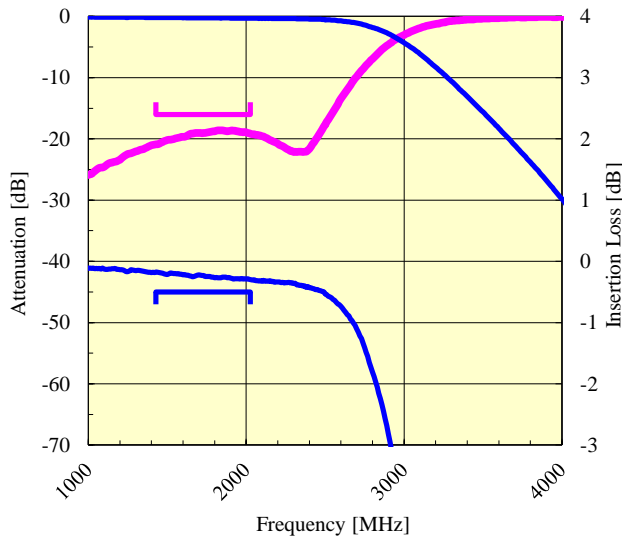

Broad Band Frequency Response

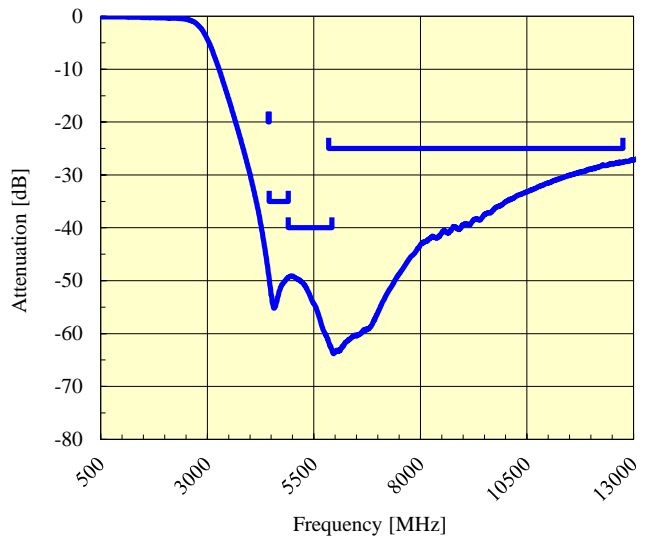

6.Recommended land pattern (Unit:mm)

*Land Pattern

*Resist Pattern

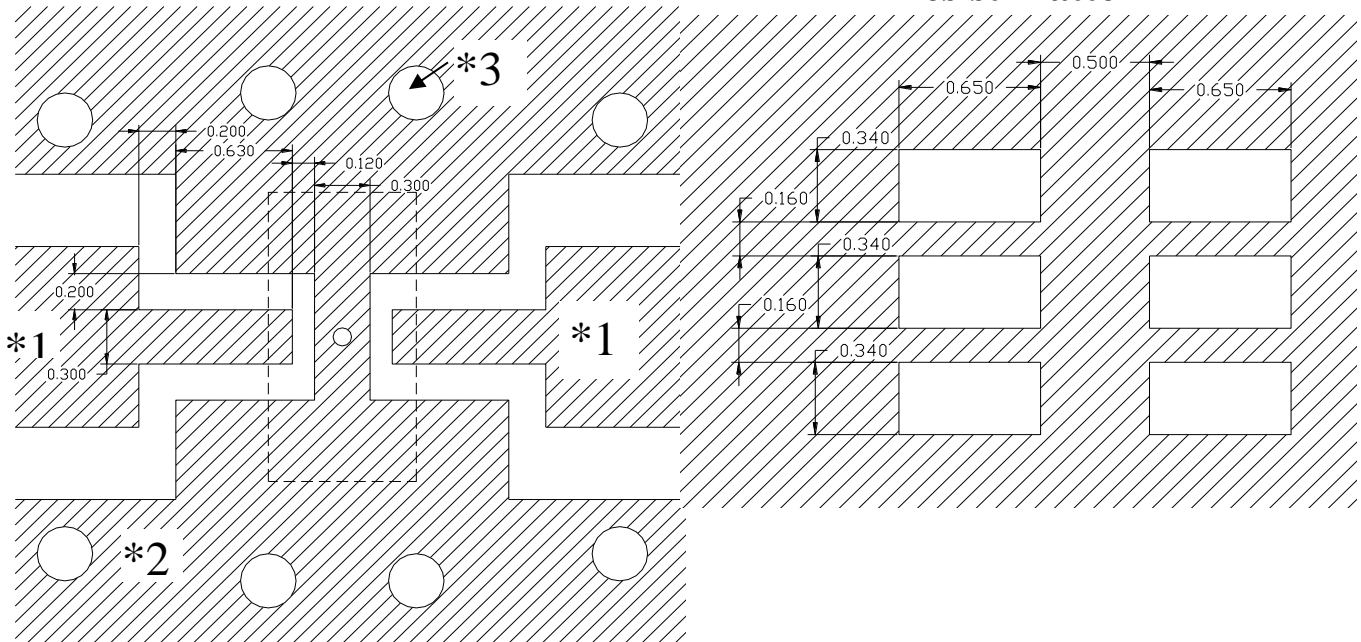

- *1 50 ohm Impedance Line
- *2 Ground Plane
- *3 Thorough Hole

7. Packing method

7.1 Taping conditions

Taping conditions are shown below. Refer to IEC60286-3

- (1) Tape must be wound clockwise with the feeding hole coming to the right hand side.
- (2) Top cover tape must not cover feeding holes of carrier tape and/or show out of carrier tape.
- (3) A blank section carrying no chips of a length of 160mm min. on ending section and 100mm min. on leading section must be provided.
- (4) A leading section of 400mm min. must be provided on top cover tape.

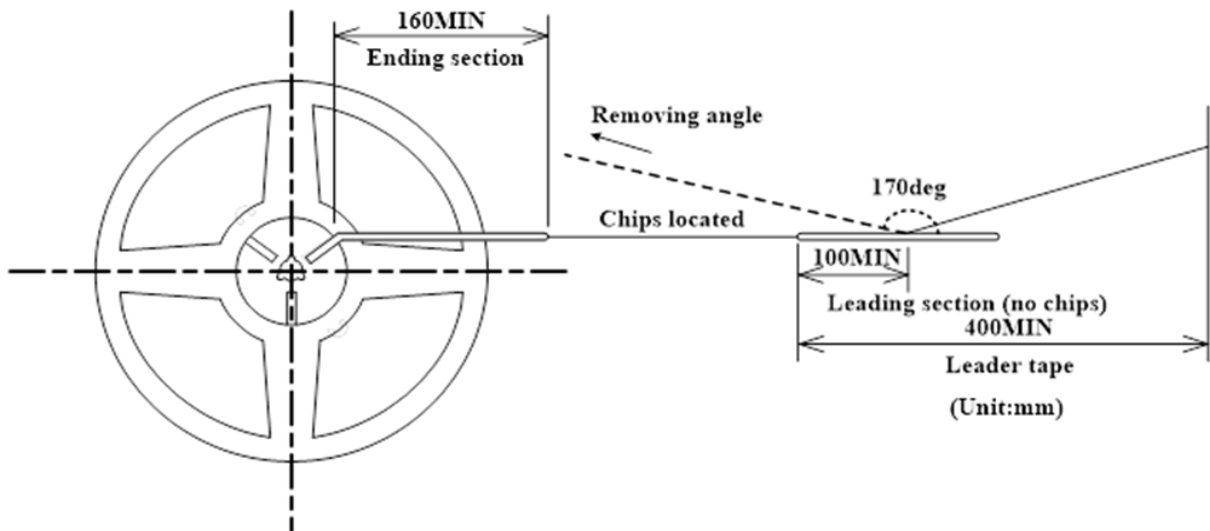

- (5) To end tape winding, the leading section of top cover tape must be stuck on a side of a reel with adhesive tape.
- (6) Removing force of top cover tape in the unwinding with an angle of 170 degrees between the removed side of a reel and carrier tape must be 0.1 to 1.0N.
- (7) When the embossed tape is turned upside down with the sealing tape peeled off, the filter body inside of the tape must fall off and the mounter must not cause a take-up mistake.
- (8) A sticker carrying Soshin product №, quantity, lot №, inspection date is to be placed on the specified side of reels. And Lot No. means our production control number. The shipment records are available if requested.

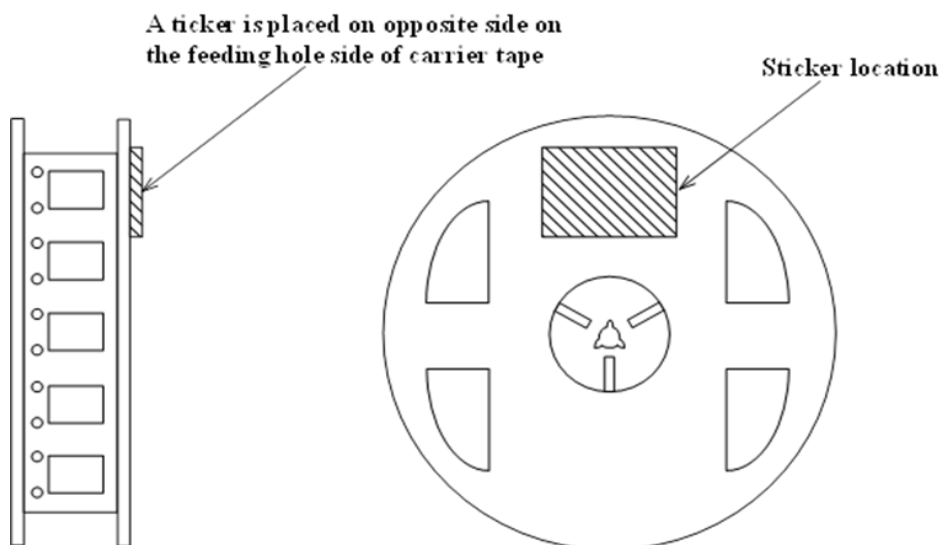

(9) Product orientation must be consistent. Products must not be positioned out of the mounting location.

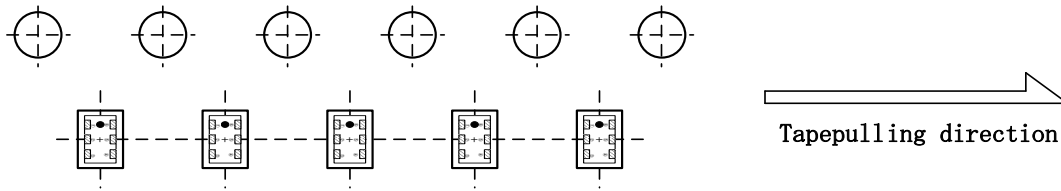

(10) A taping reel must be sealed in a plastic bag, individually.

(11) Tape-packaged quantity

The quantity is 3,000 pcs per single tape-package as a rule.

7.2 Dimensions of the carrier tape (Unit : mm)

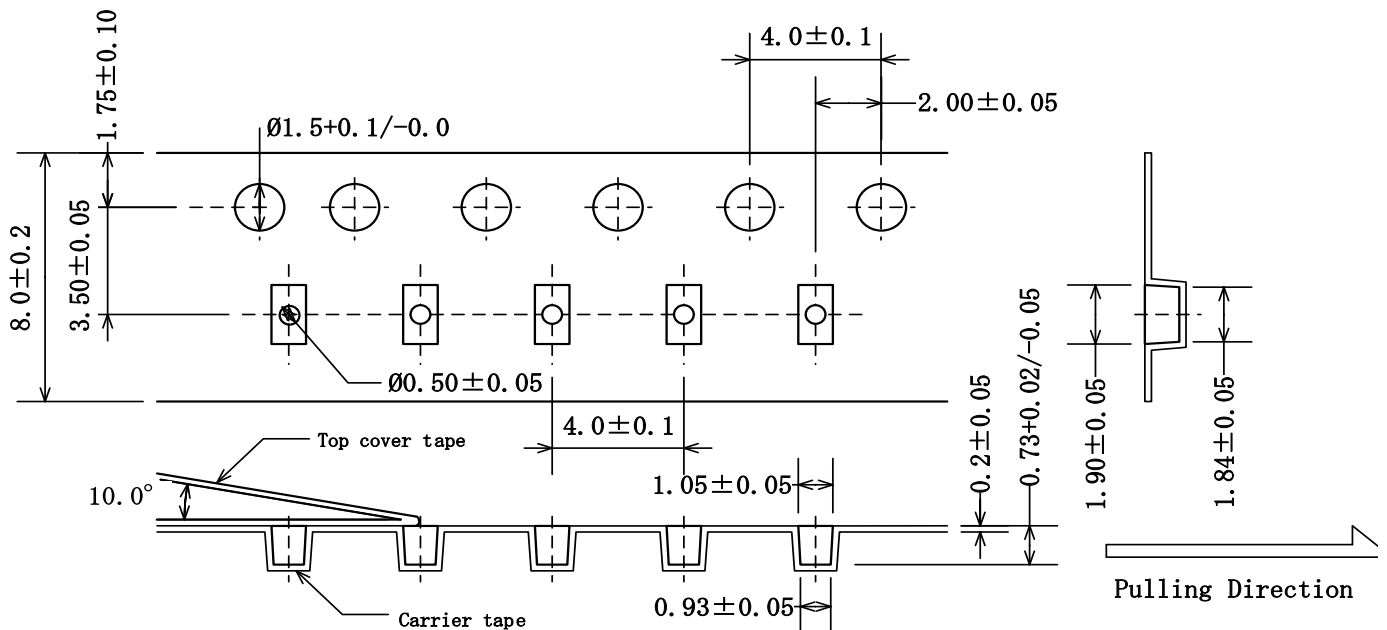

7.3 Carrier tape reel dimensions (Unit : mm)

