

NF3000C-UQA Series (RoHS Compliant)

3-phase 3-line 480VAC Large current, small footprint (Low Leakage)



400A

UL1283 (file No.E102708)
EN60939-2 (file No.R50031225)

Applications

IGBT Inverter, AC Servo, NC Machinery

Specifications

Part No.	Rated Current	Weight	
NF3200C-UQA	200A	10Kg	fig1
NF3250C-UQA	250A	11Kg	
NF3300C-UQA	300A	12Kg	
NF3400C-UQA	400A	20Kg	fig2
NF3500C-UQA	500A	26Kg	fig3
NF3600C-UQA	600A	26Kg	
NF3700C-UQA	700A	38Kg	fig4
NF3800C-UQA	800A	38Kg	
NF3900C-UQA	900A	60Kg	fig5
NF31000C-UQA	1000A	60Kg	
Rated Voltage	480VAC max		
Leakage Current	10mA max/400VAC 50Hz By UL1283		
Ambient temp.			

fig. 1 (200, 250, 300A)

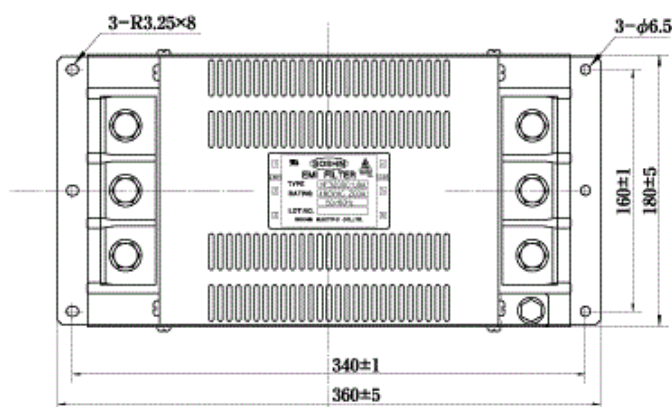

No	Item	Notes
①	Input terminal	M10
②	Metal case	
③	Label	
④	Output terminal	M10
⑤	Earthing terminal	M8

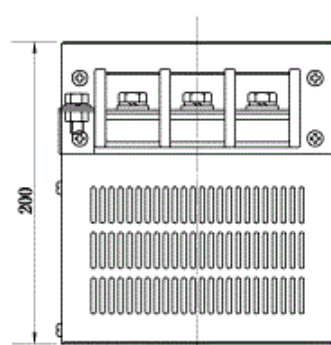
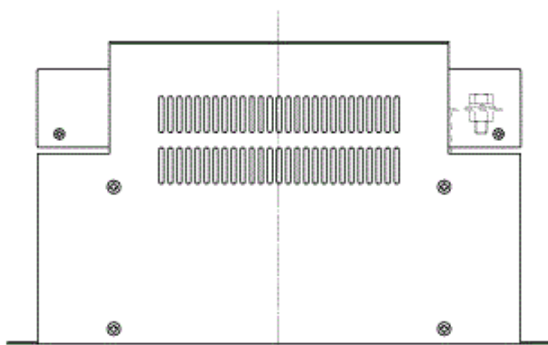
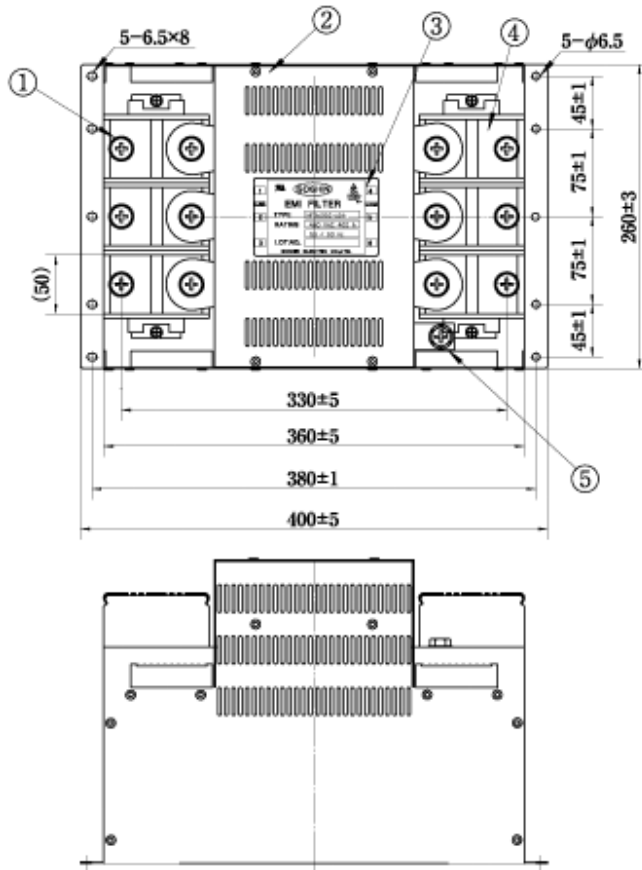

fig. 2 (400A)



No	Item	Notes
①	Input terminal	M12
②	Metal case	
③	Label	
④	Output terminal	M12
⑤	Earthing terminal	M10

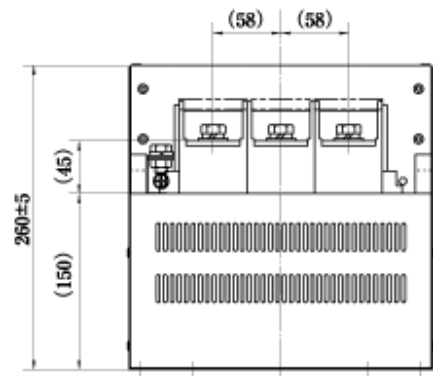
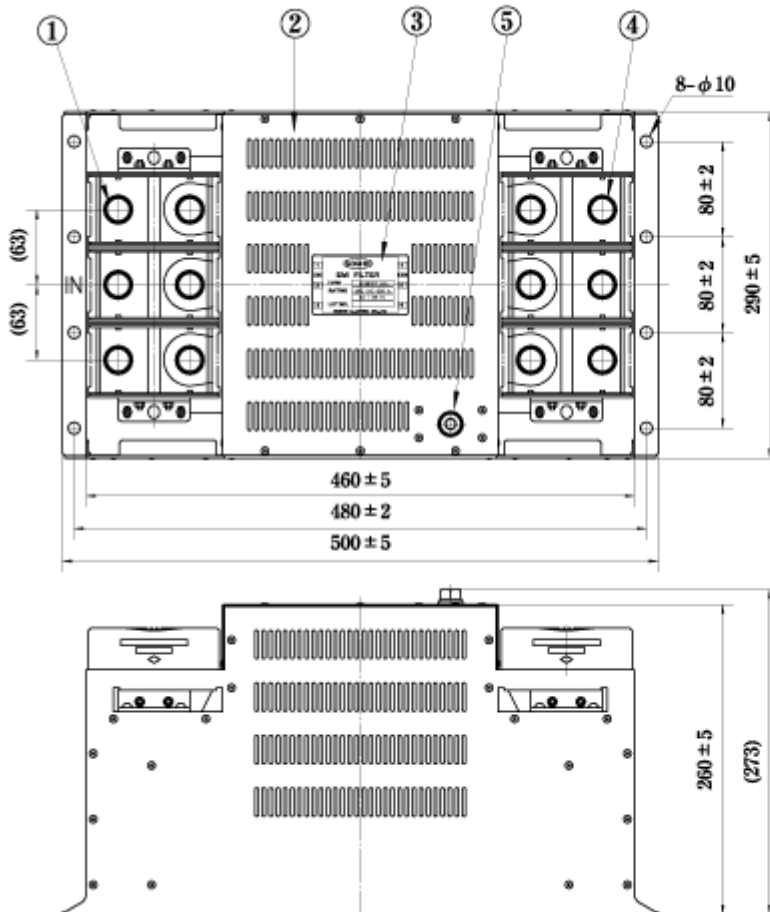

fig. 3 (500, 600A)



No	Item
1	Input terminal (M12)
2	Metal case
3	Label
4	Output terminal (M12)
5	Earthing terminal (M10)

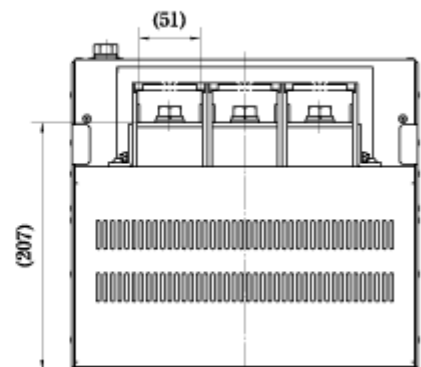

fig. 4 (700, 800A)

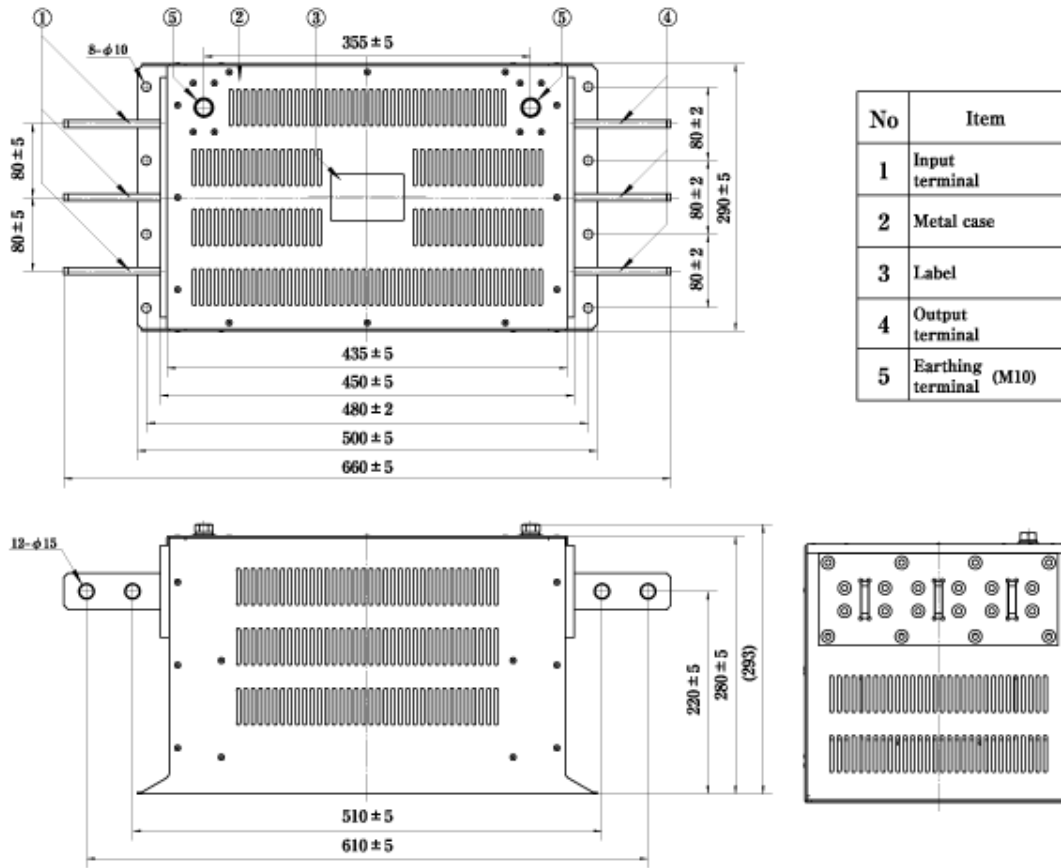
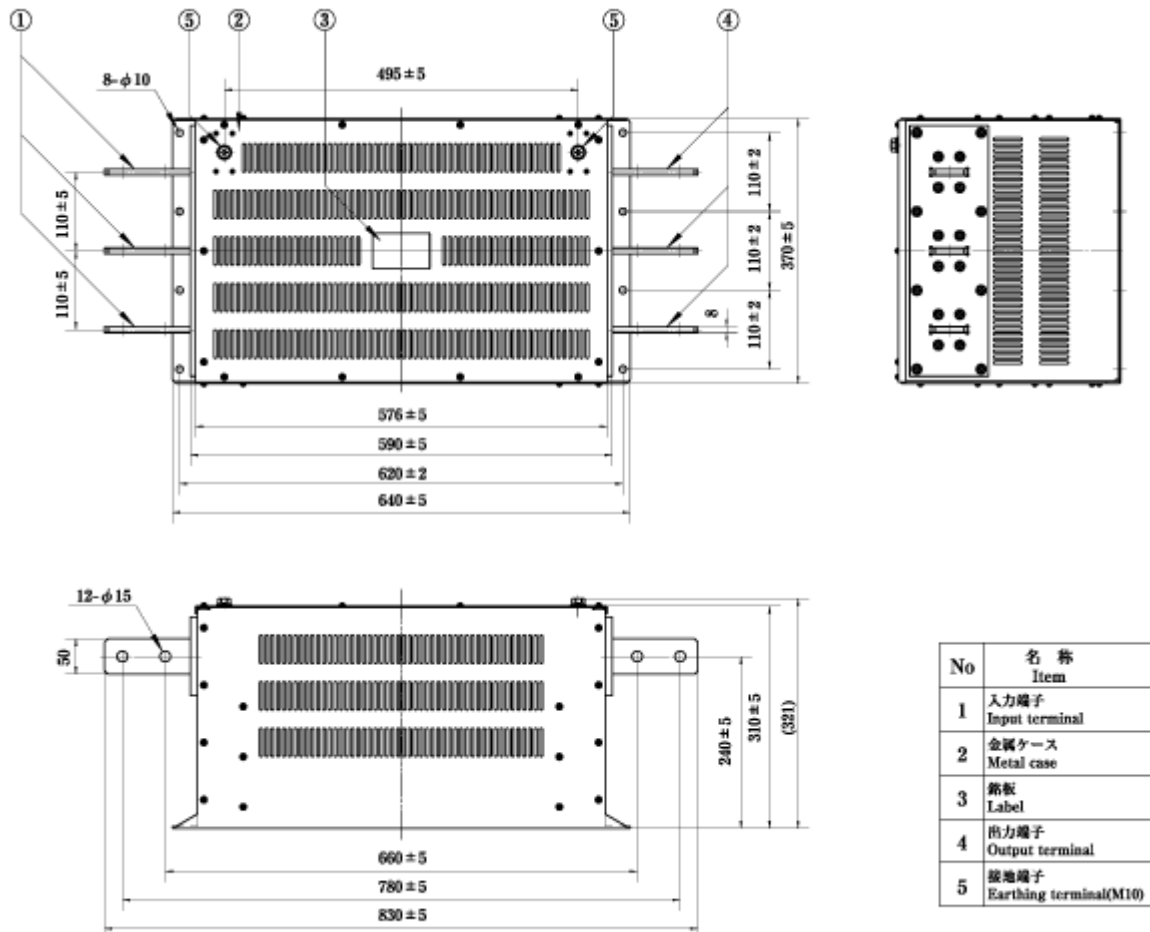
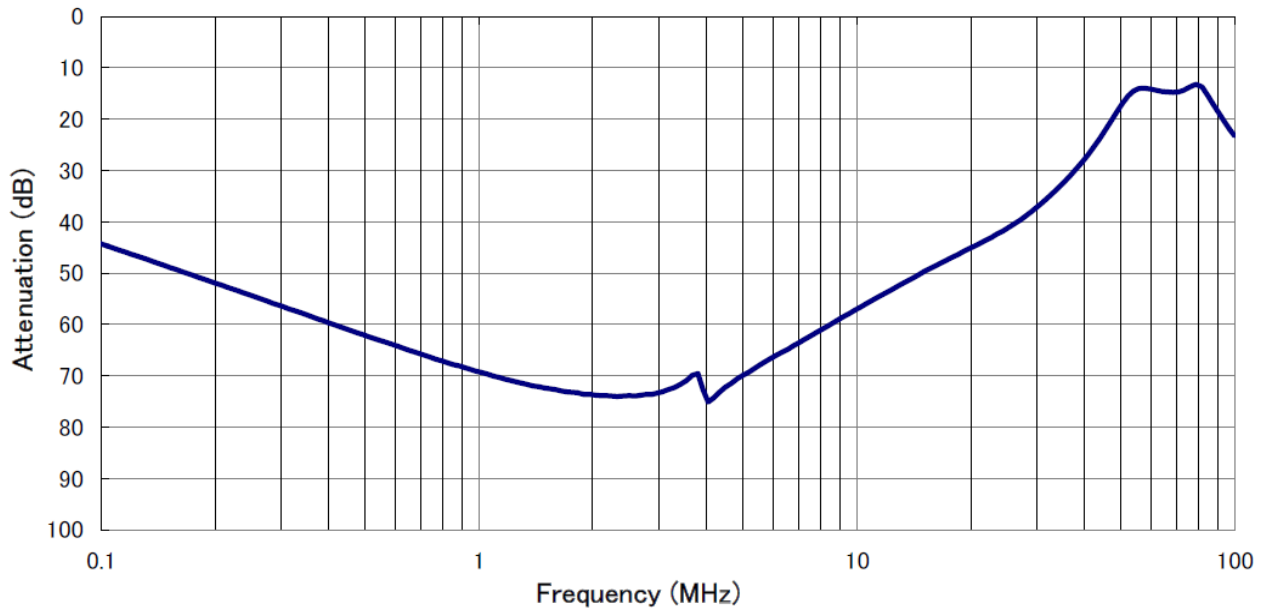

fig. 5 (900, 1000A)



Attenuation Characteristics (200A)



Attenuation Characteristics (600A)

