

HF3000C-SZC Series (RoHS 対応品)

三線三相式 500VAC

ブック型高減衰汎用タイプ



100A品 外観

UL1283/CSA C22.2 No8(C-UL) (file No.E102708)
EN60939-2 (file No.R50147299)

用途

工作機械、汎用インバータ、ACサーボなど

仕様

Parts No.	Rated Current	Weight	
HF3010C-SZC	10A	0.9Kg	fig1
HF3020C-SZC	20A	1.3Kg	
HF3030C-SZC	30A	1.3Kg	
HF3040C-SZC	40A	2Kg	fig2
HF3050C-SZC	50A	2Kg	
HF3060C-SZC	60A	2.1Kg	fig3
HF3080C-SZC	80A	5.4Kg	
HF3100C-SZC	100A	5.8Kg	fig4
HF3150C-SZC	150A	9.0Kg	fig5
HF3200C-SZC	200A	11Kg	
HF3250C-SZC	250A	12Kg	
HF3300C-SZC	300A	13Kg	
Rated Voltage	530VAC max		
Leakage Current	7mA max/400VAC 50Hz By UL1283		
Ambient temp.	-20 up to 50 Deg.C		

fig.1 (10-30A)

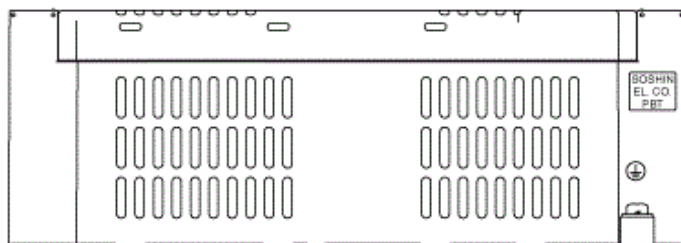
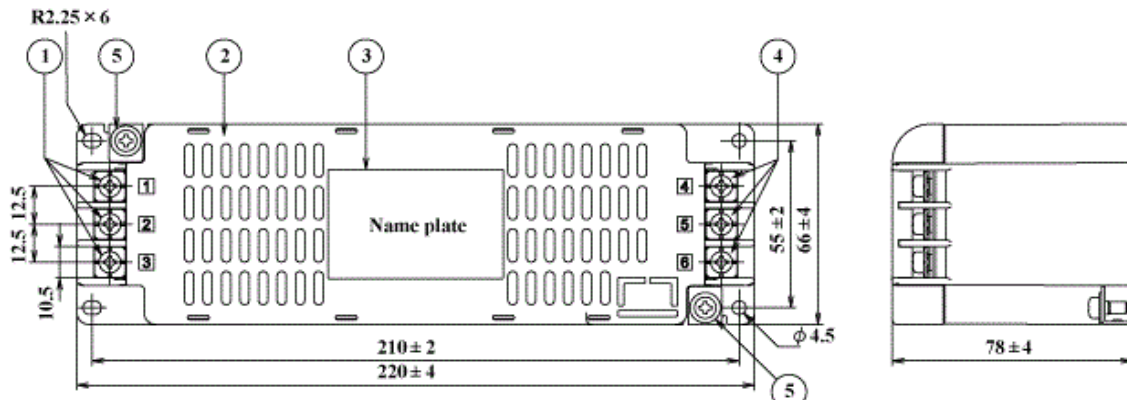

No	Part name	Note
1	Input terminal	M4
2	Case	PBT
3	Name plate	
4	Output terminal	M4
5	Earth terminal	M4

fig.2 (40-60A)

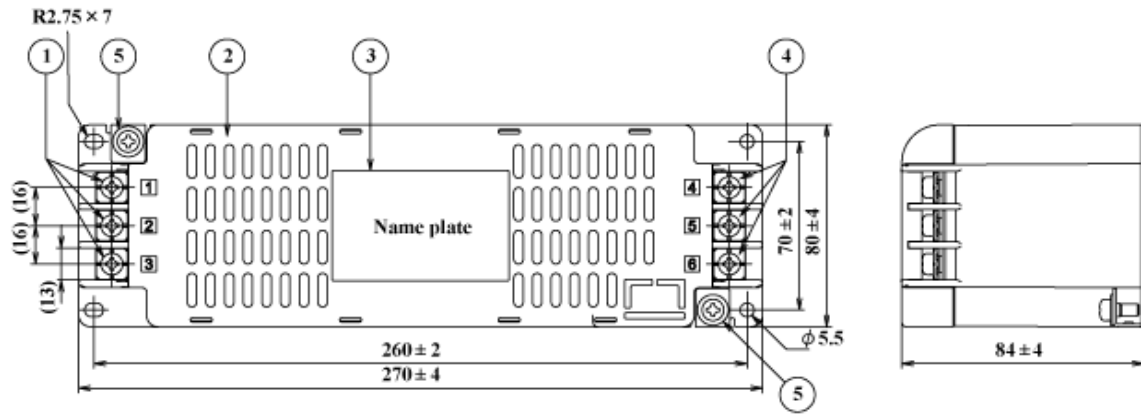

No	Part name	Note
1	Input terminal	M5
2	Case	PBT
3	Name plate	
4	Output terminal	M5
5	Earth terminal	M4

fig.3 (80A, 100A)

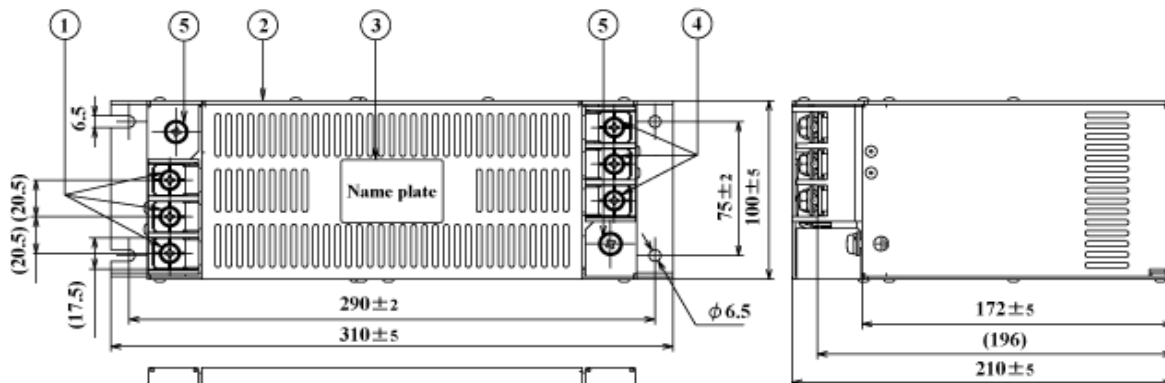

No	Part name	Note
1	Input terminal	M6
2	Case	
3	Name plate	
4	Output terminal	M6
5	Earth terminal	M6

fig.4 (150A)

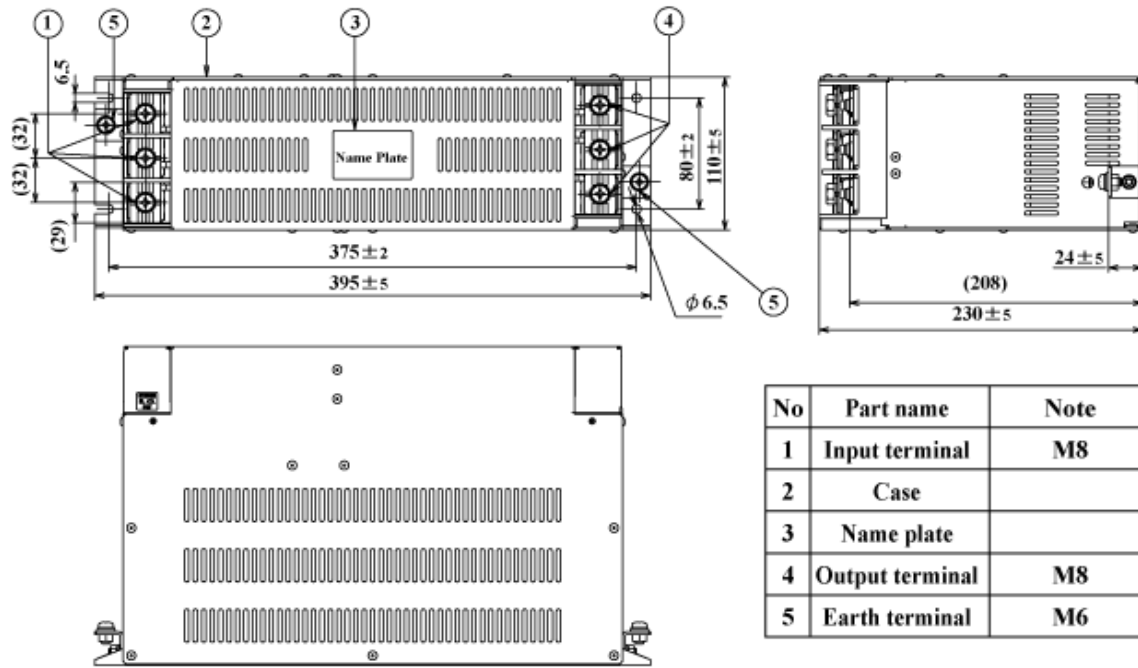
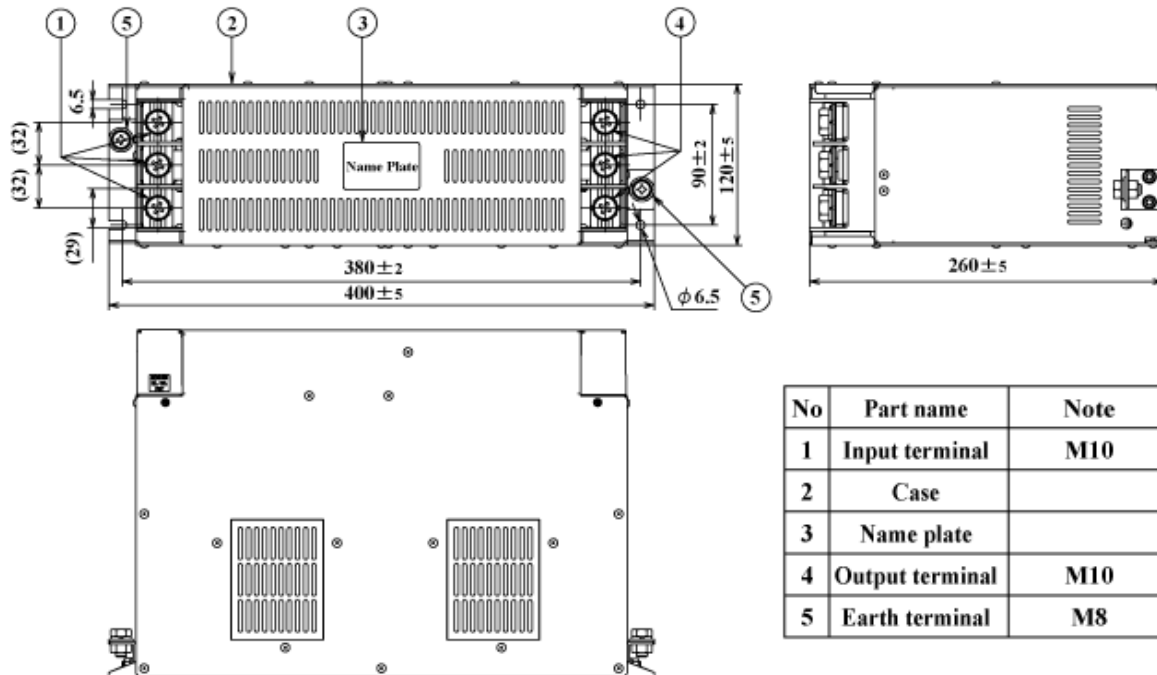
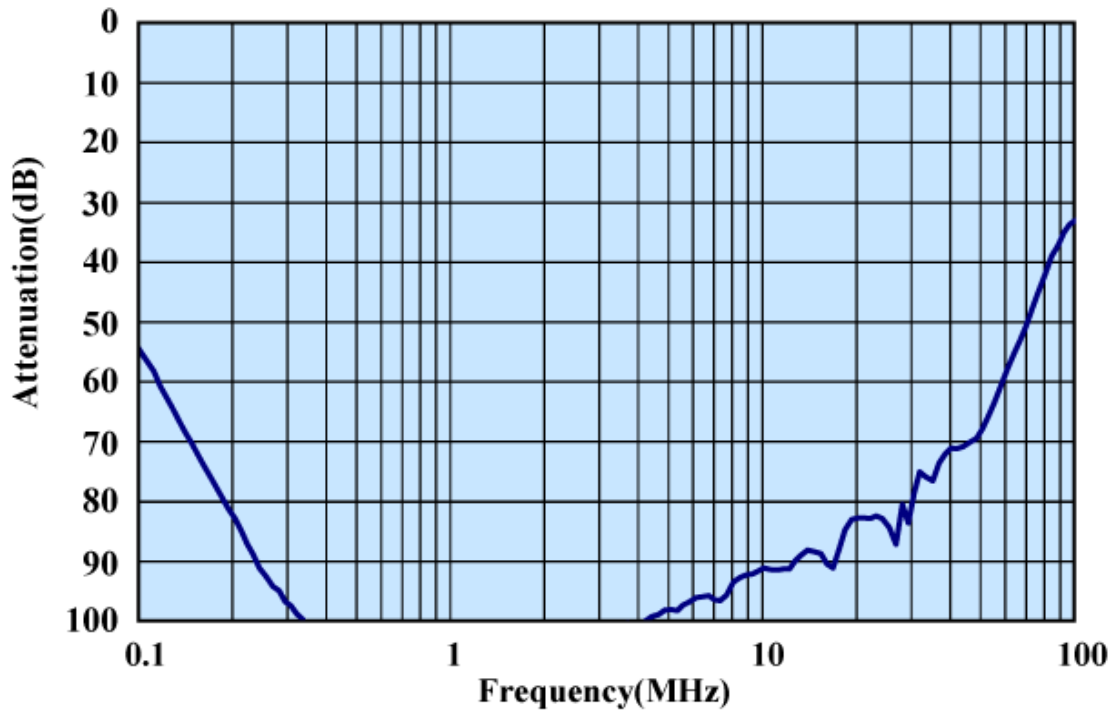

fig.5 (200-300A)



代表特性 (50A)



代表特性 (100A)

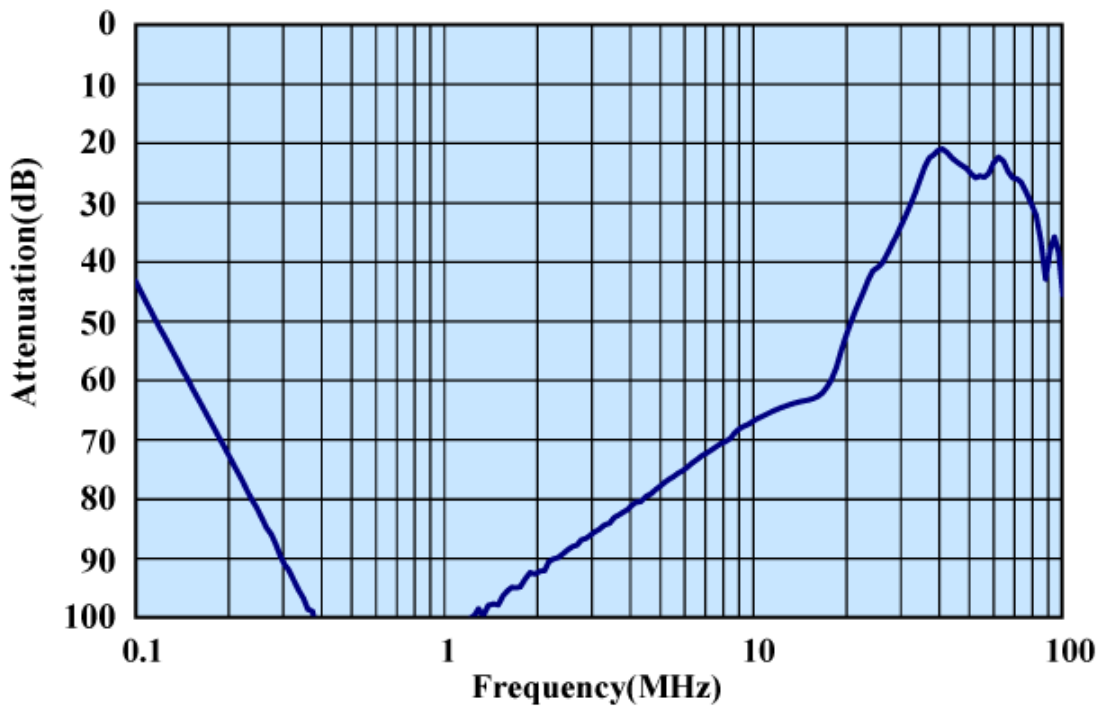

回路图

