

HF3000C-UQC Series (RoHS 対応品)

三相三線式 480VAC

高減衰・大電流(低漏洩電流タイプ)



150A品 外観



UL1283 (file No.E102708)
EN60939-2 (file No.R50031225)

用途

IGBTインバータ、ACサーボ、NC制御機器など

仕様

Part No.	Rated Current	Weight	
HF3010C-UQC	10A	2.2kg	fig1
HF3020C-UQC	20A	2.8kg	
HF3030C-UQC	30A	3.3kg	
HF3040C-UQC	40A	4kg	
HF3050C-UQC	50A	4kg	
HF3060C-UQC	60A	4.5kg	fig2
HF3080C-UQC	80A	9kg	
HF3100C-UQC	100A	11kg	fig3
HF3150C-UQC	150A	14kg	
HF3200C-UQC	200A	20kg	
HF3250C-UQC	250A	21kg	fig4
HF3300C-UQC	300A	22kg	
HF3400C-UQC	400A	33kg	fig5
Rated Voltage	480VAC max		
Leakage Current	10mA max / 400VAC 50Hz By UL1283		
Ambient temp.	-20 up to 50 Deg.C		

fig.1 (10-60A)

Model Name	Size (mm)										
	A	B	C	D	E	F	G	H	J	K	L
HF3010C-UQC	186	171	156	136	98	84	73	95	φ4.5×6	M4	M4
HF3020C-UQC	236	221	206	184	105	90	76	122	φ5.5×7	M5	M5
HF3030C-UQC											
HF3040C-UQC											
HF3050C-UQC	256	241	226	204	115	100	86	127	φ5.5×7	M5	M5
HF3060C-UQC											

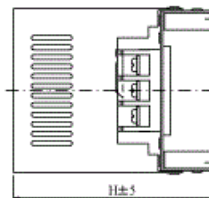
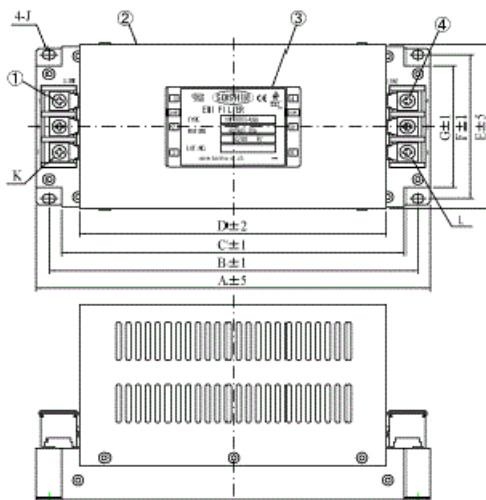

No	Item
1	Input terminal
2	Resin case
3	Label
4	Output terminal

fig.2 (80, 100A)

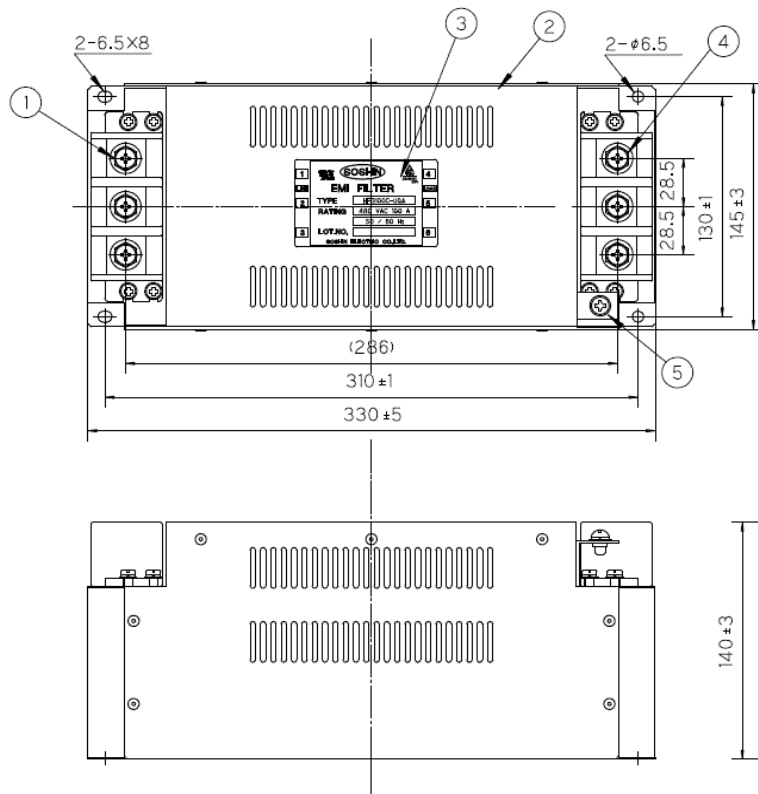

No.	名称 Item	規格 Standard
1	入力端子 INPUT terminal	M8
2	金属ケース Metal case	
3	銘板 Label	
4	出力端子 Output terminal	M8
5	接地端子 Earthing terminal	M6

fig. 3 (150A)

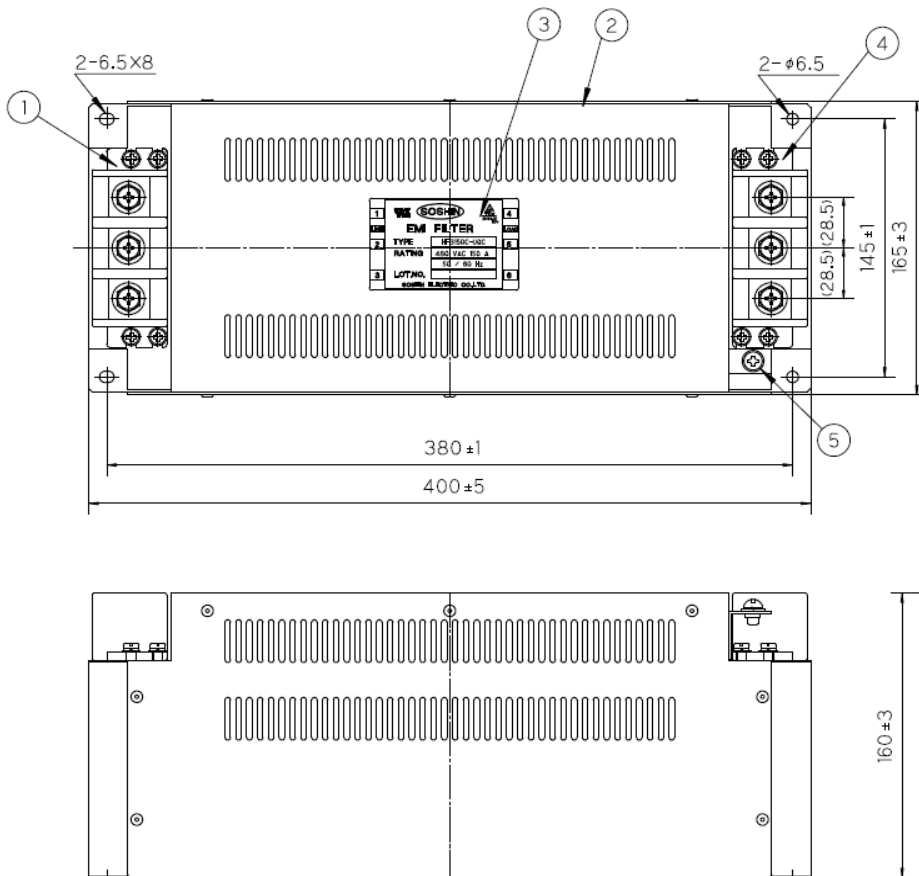

No.	名称 Item	規格 Standard
1	入力端子 INPUT terminal	M8
2	金属ケース Metal case	
3	銘板 Label	
4	出力端子 Output terminal	M8
5	接地端子 Earthing terminal	M6

fig. 4 (200, 250, 300A)

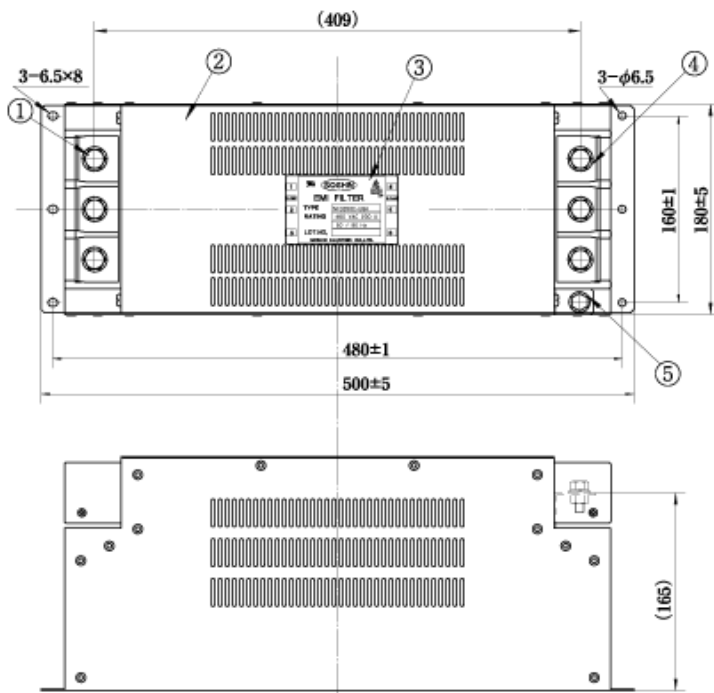

No	Item	Notes
①	Input terminal	M10
②	Metal case	
③	Label	
④	Output terminal	M10
⑤	Earthing terminal	M8

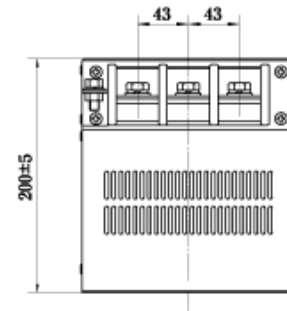
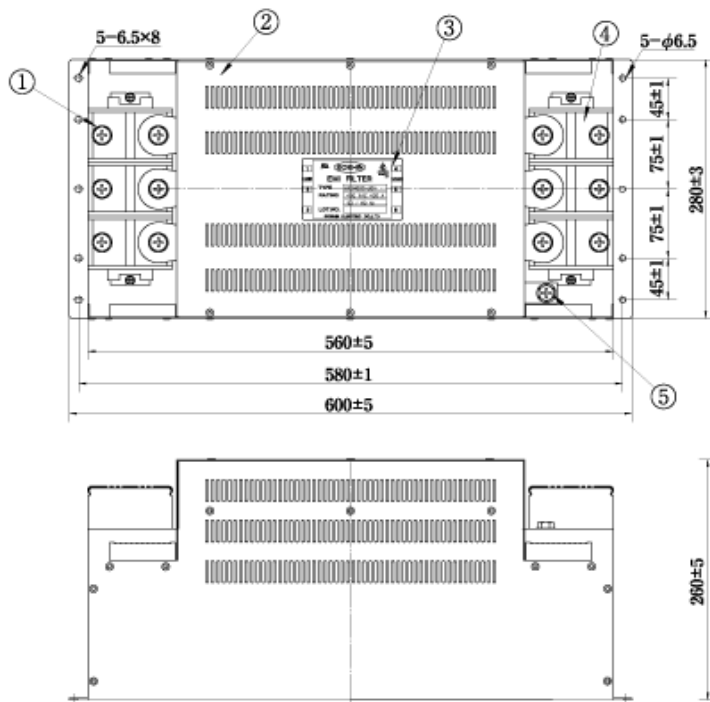
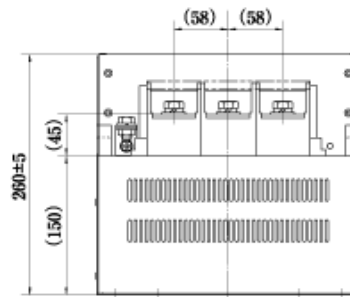

fig. 5 (400A)



No	Item	Notes
①	Input terminal	M12
②	Metal case	
③	Label	
④	Output terminal	M12
⑤	Earthing terminal	M10



減衰特性

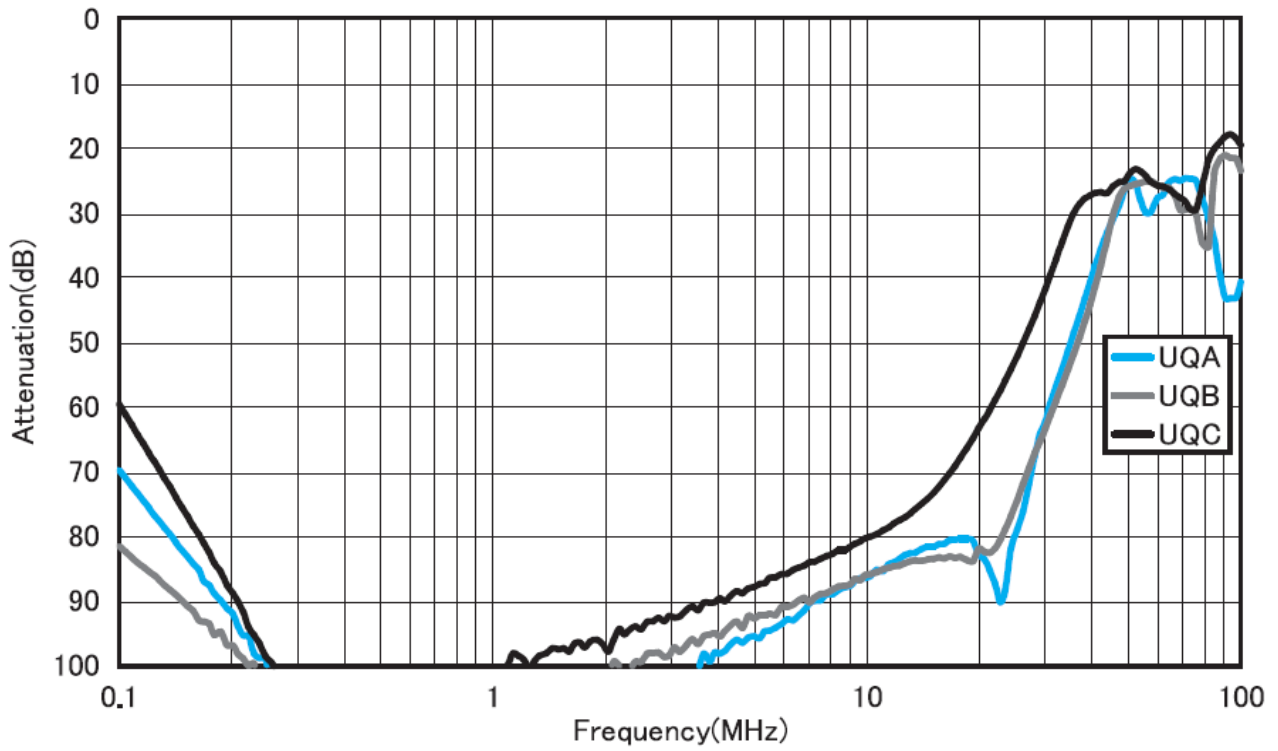

回路図

