

# NF3000C-VZ Series (RoHS 対応品)

三相三線式 500VAC

ブロックコンデンサと筐体の一体化構造で  
小型・低背型を実現しました。当社従来比1/2



UL1283 (file No.E102708)  
EN60939-2 (file No.R50031313)

## 用途

伝送通信装置、汎用インバータ、UPS、CVCF、VVVF等

## 仕様

Part No.	Rated Current	Weight	Dimensions [mm]																		
			A	B	C	D	E	F	G	H	J	K	L	M	N	P	Q	R	S		T
NF3010C-VZ	10A	0.5Kg	128	118	108	63	43	42	1	4.5x6	dia.4.5	M4	M4	21	88	21	19	35	10	2	fig1
NF3020C-VZ	20A	0.5Kg	128	118	108	63	43	42	1	4.5x6	dia.4.5	M4	M4	21	88	21	19	35	10	2	
NF3030C-VZ	30A	0.7Kg	145	135	125	70	50	42	1	4.5x6	dia.4.5	M4	M4	25	103	22	20	35	10	2	
NF3040C-VZ	40A	1.3Kg	179	167	155	90	70	54	1.6	4.5x6	dia.4.5	M5	M4	32	131	25	23	45	14	3	
NF3050C-VZ	50A	1.3Kg	179	167	155	90	70	54	1.6	4.5x6	dia.4.5	M5	M4	32	131	25	23	45	14	3	
NF3060C-VZ	60A	1.5Kg	179	167	155	90	70	54	1.6	4.5x6	dia.4.5	M5	M4	32	131	25	23	45	14	3	fig2
NF3080C-VZ	80A	3.0Kg	260	245	230	189	144.5	120	90	80	61	12	6.5	M8	M5	-	-	-	-	-	
NF3100C-VZ	100A	3.0Kg	260	245	230	189	144.5	120	90	80	61	12	6.5	M8	M5	-	-	-	-	-	fig3
NF3150C-VZ	150A	5.5Kg	285	270	255	216	171	170	100	105	89	67	6.5	M8	M8	-	-	-	-	-	
NF3200C-VZ	200A	10Kg																		fig4	
NF3250C-VZ	250A	11Kg																			
NF3300C-VZ	300A	12Kg																			
NF3400C-VZ	400A	18Kg																			fig5
Rated Voltage	10-150A:500VAC,200-400A:480VAC																				
Leakage Current	10-150A: 3.0mA/200-400: 10mA																				
Ambient temp.	-20 up to 50 Deg.C (TUV : -20 up to 60 Deg.C)																				

fig. 1 (10-60A)

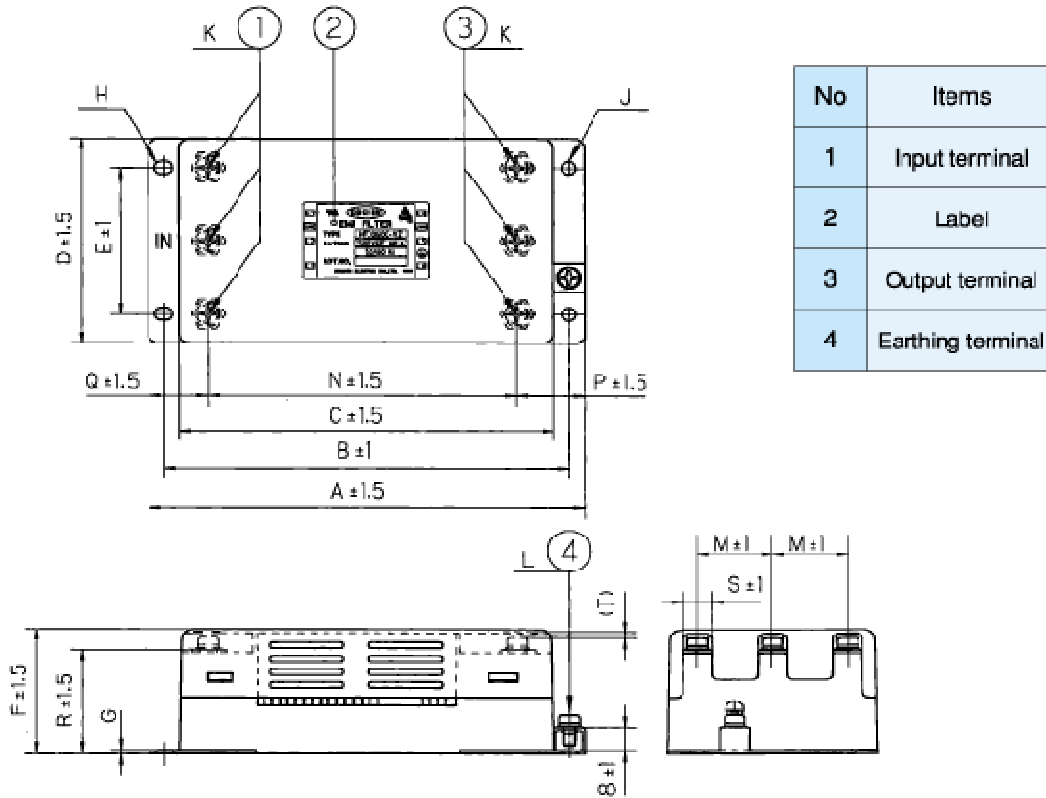

fig. 2 (80, 100A)

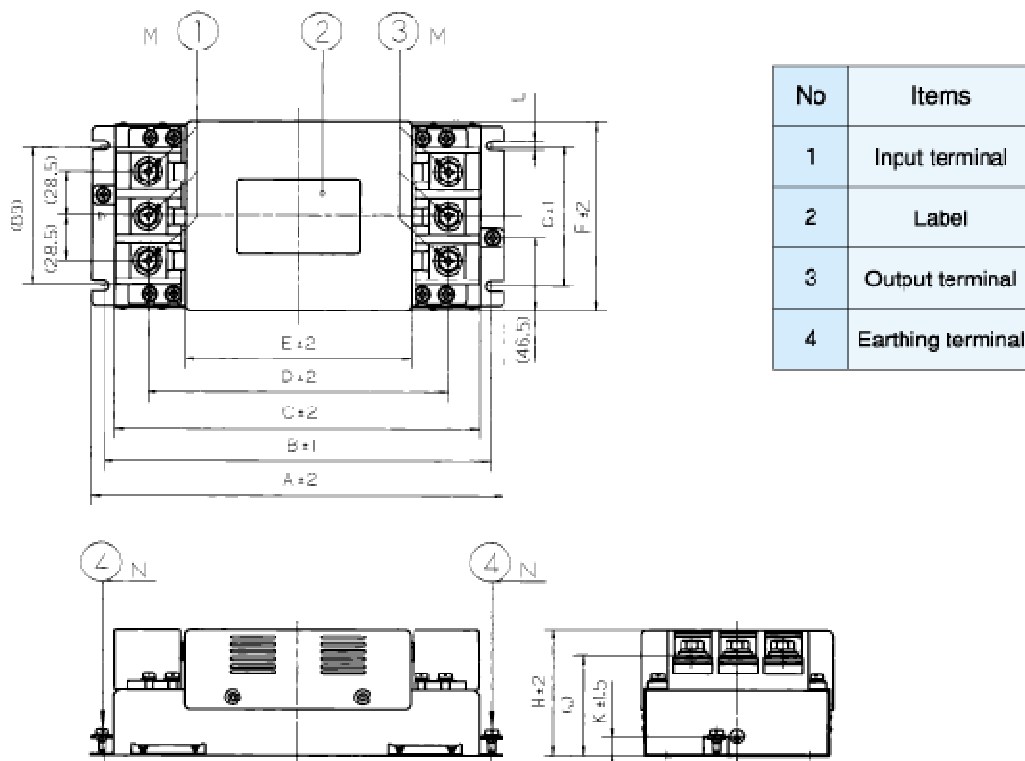

fig. 3 (150A)

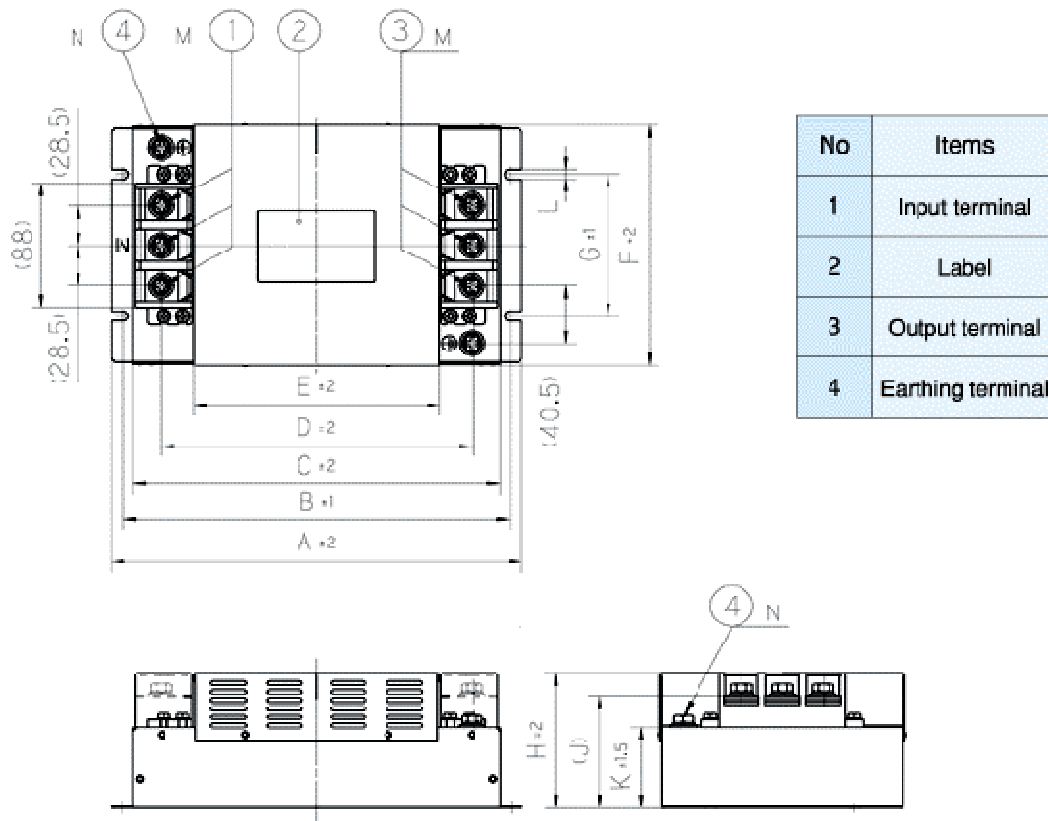

fig. 4 (200, 250, 300A)

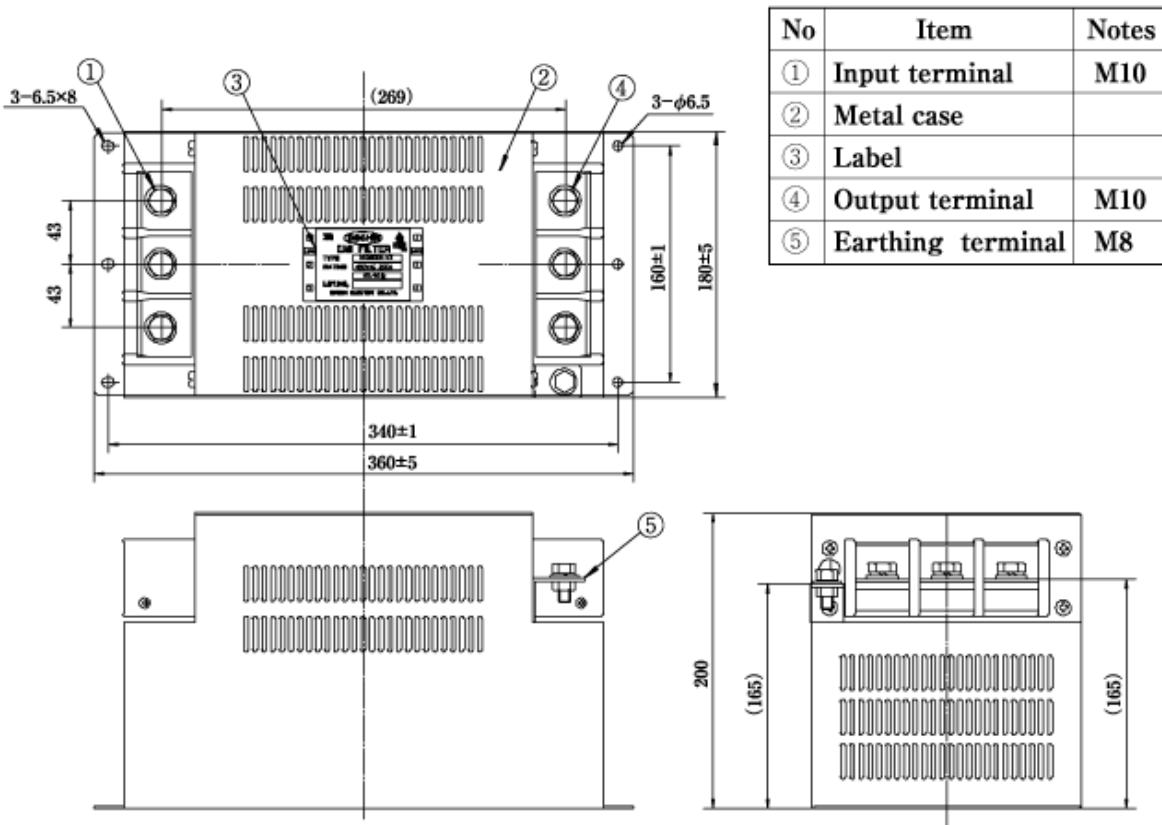
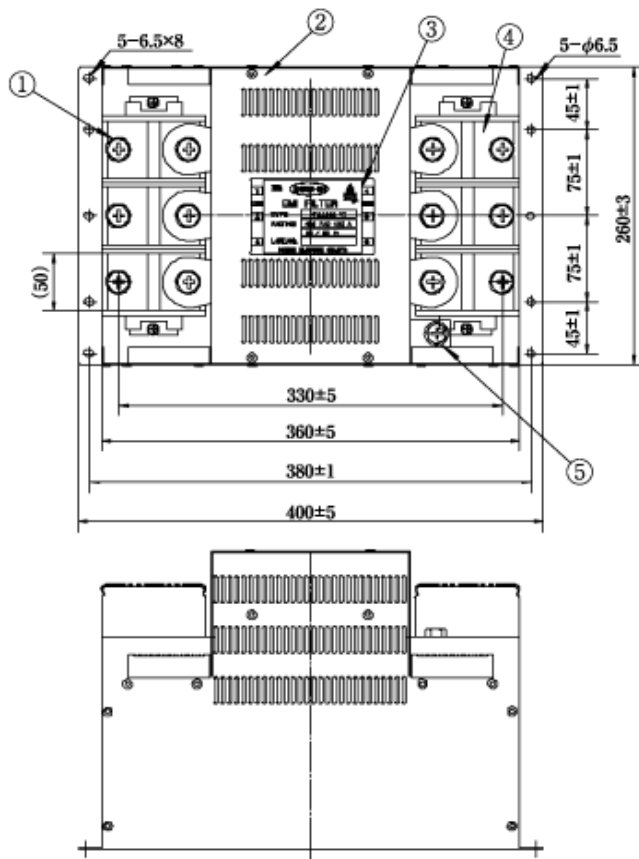
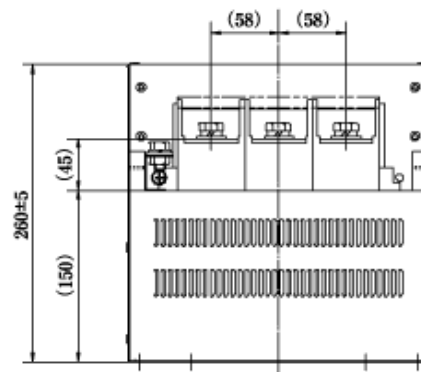

fig. 5 (400A)



No	Item	Notes
①	Input terminal	M12
②	Metal case	
③	Label	
④	Output terminal	M12
⑤	Earthing terminal	M10



代表特性 (50A)

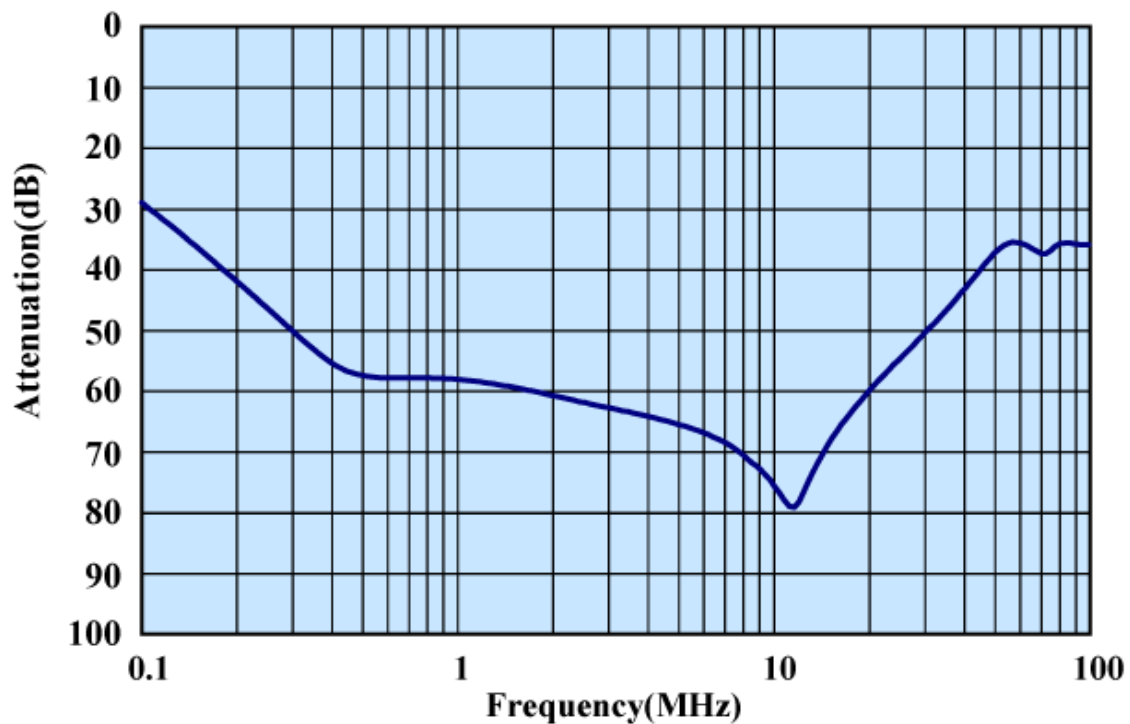

代表特性 (100A)

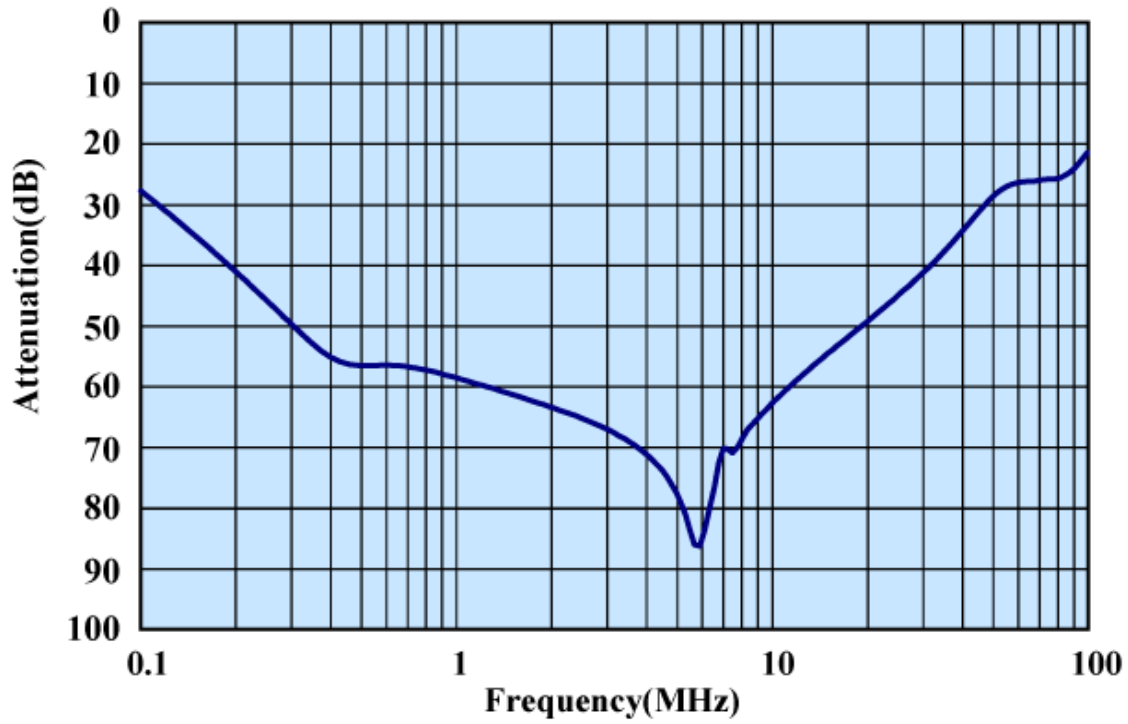

回路図

