

HF3000C-UQA Series (RoHS认证产品)

三相三线式 480VAC

高衰减大电流型(低泄漏电流型)



150A产品 外观



UL1283 (file No.E102708)
EN60939-2 (file No.R50031225)
SCCR对应品

- 与断路器组合取得
- 若为Listed认证品, 可使用任何厂家的断路器

用途

IGBT变频器、AC伺服、NC控制器等

规格

Part No.	Rated Current	SCCR value	Weight	Dimensions [mm]											fig1
				A	B	C	D	E	F	G	H	J	K	L	
HF3010C-UQA	10A	-	2.2kg	186	171	156	136	98	84	73	95	φ4.5×6	M4	M4	fig1
HF3020C-UQA	20A		2.8kg	236	221	206	184	105	90	76	122				
HF3030C-UQA	30A		3.3kg												
HF3040C-UQA	40A		4.0kg	256	241	226	204	115	100	86	127	φ5.5×7	M5	M5	
HF3050C-UQA	50A		4.5kg												
HF3060C-UQA	60A		4.5kg	9.0kg	参照fig2										
HF3080C-UQA	80A	30kA	11.0kg	参照fig3											
HF3100C-UQA	100A		14.0kg	参照fig4											
HF3150C-UQA	150A		20.0kg	参照fig5											
HF3200C-UQA	200A	42kA	21.0kg	参照fig4											
HF3250C-UQA	250A		22.0kg	参照fig5											
HF3300C-UQA	300A		33.0kg	参照fig5											
HF3400C-UQA	400A		33.0kg	参照fig5											
Rated Voltage	480VAC max														
Leakage Current	10mA max / 400VAC 50Hz By UL1283														
Ambient temp.	-20 up to 50 Deg.C														

fig.1 (10-60A)

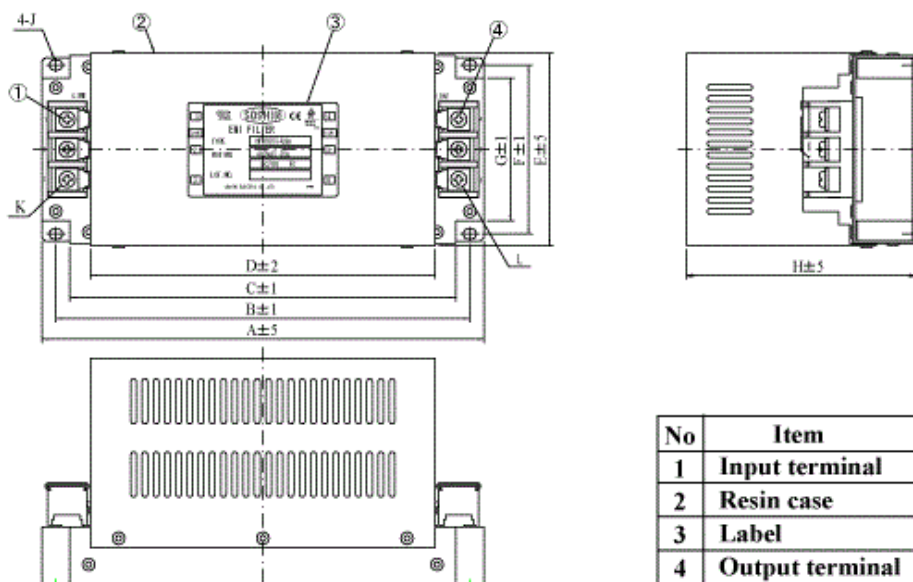

fig.2 (80, 100A)

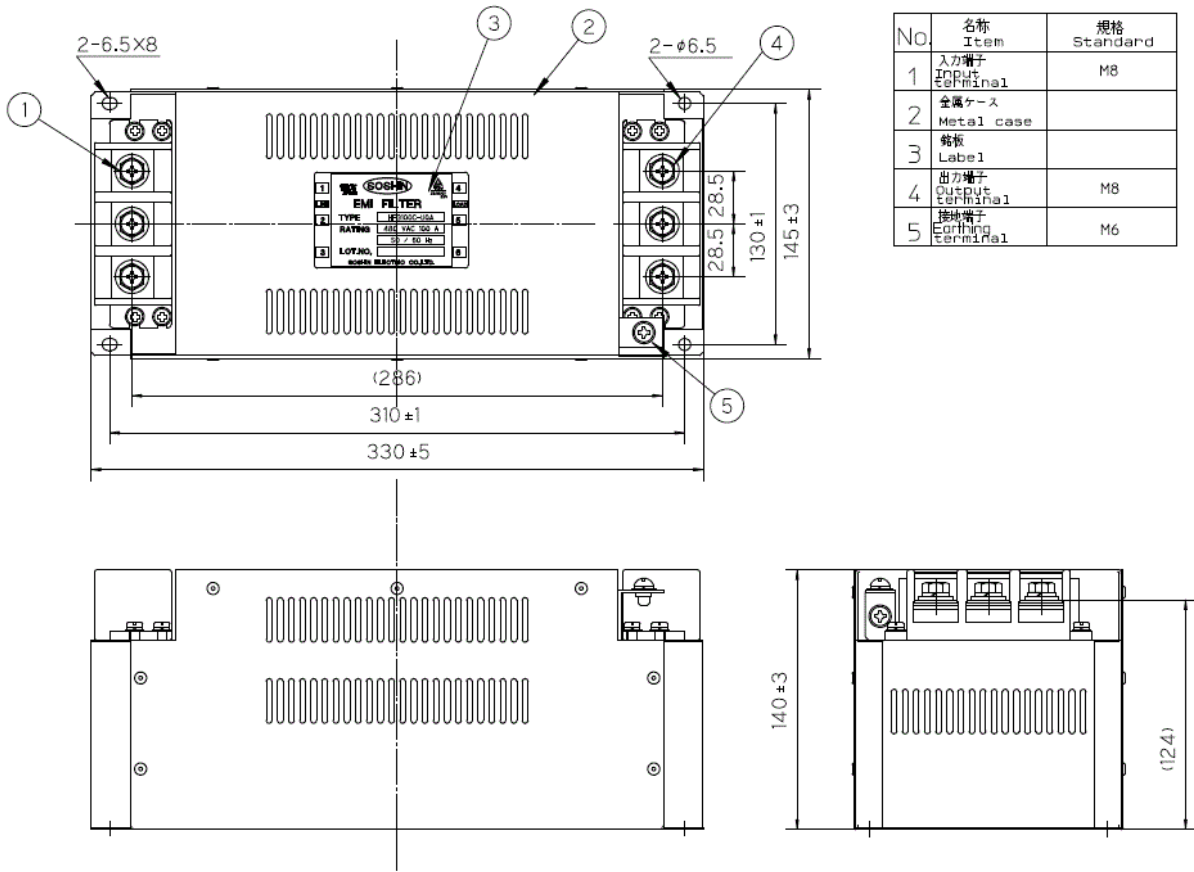

fig. 3 (150A)

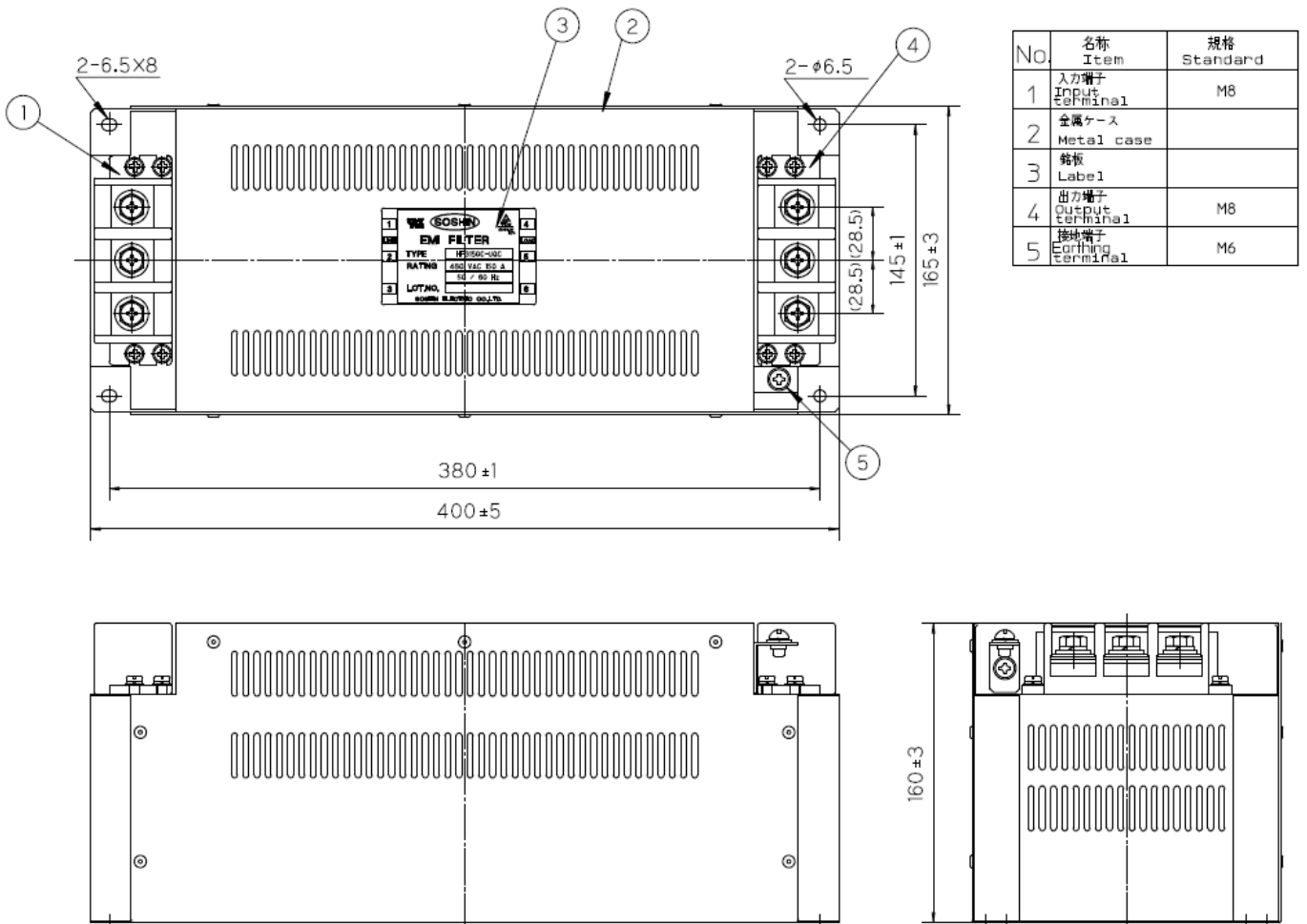
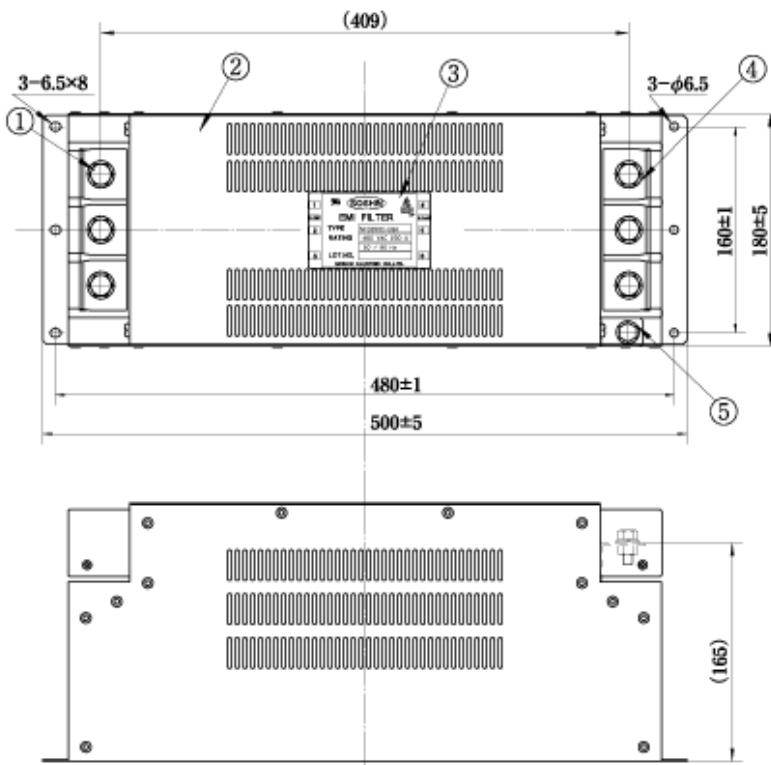

fig. 4 (200, 250, 300A)



No	Item	Notes
①	Input terminal	M10
②	Metal case	
③	Label	
④	Output terminal	M10
⑤	Earthing terminal	M8

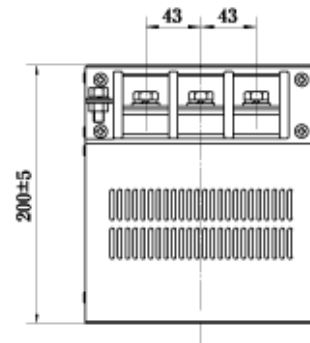
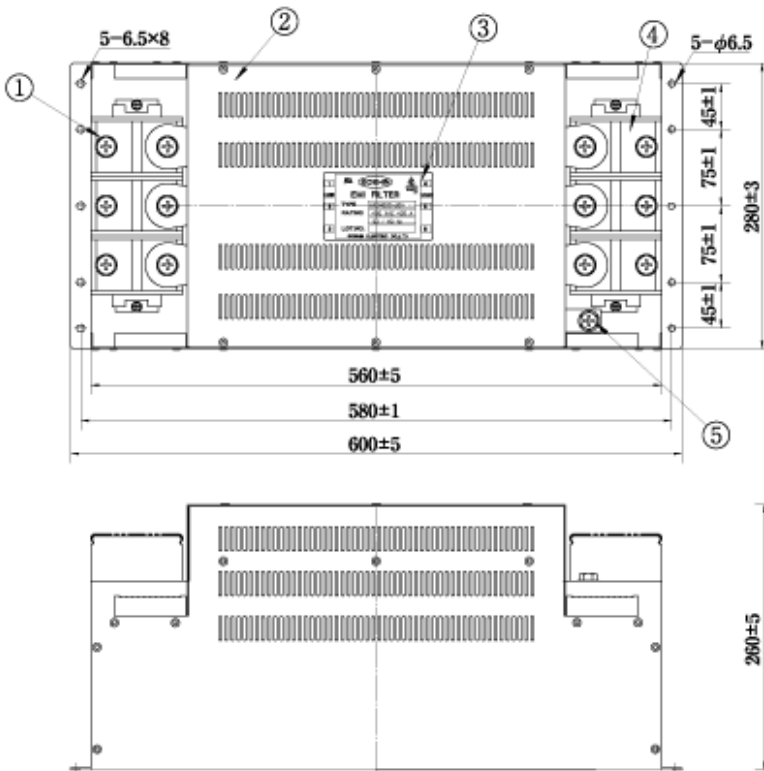
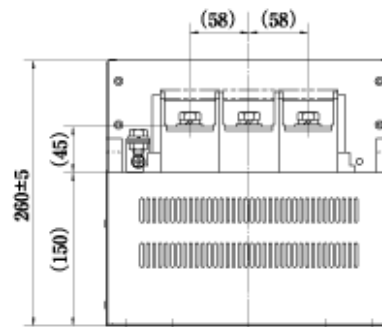

fig. 5 (400A)



No	Item	Notes
①	Input terminal	M12
②	Metal case	
③	Label	
④	Output terminal	M12
⑤	Earthing terminal	M10



衰减特性

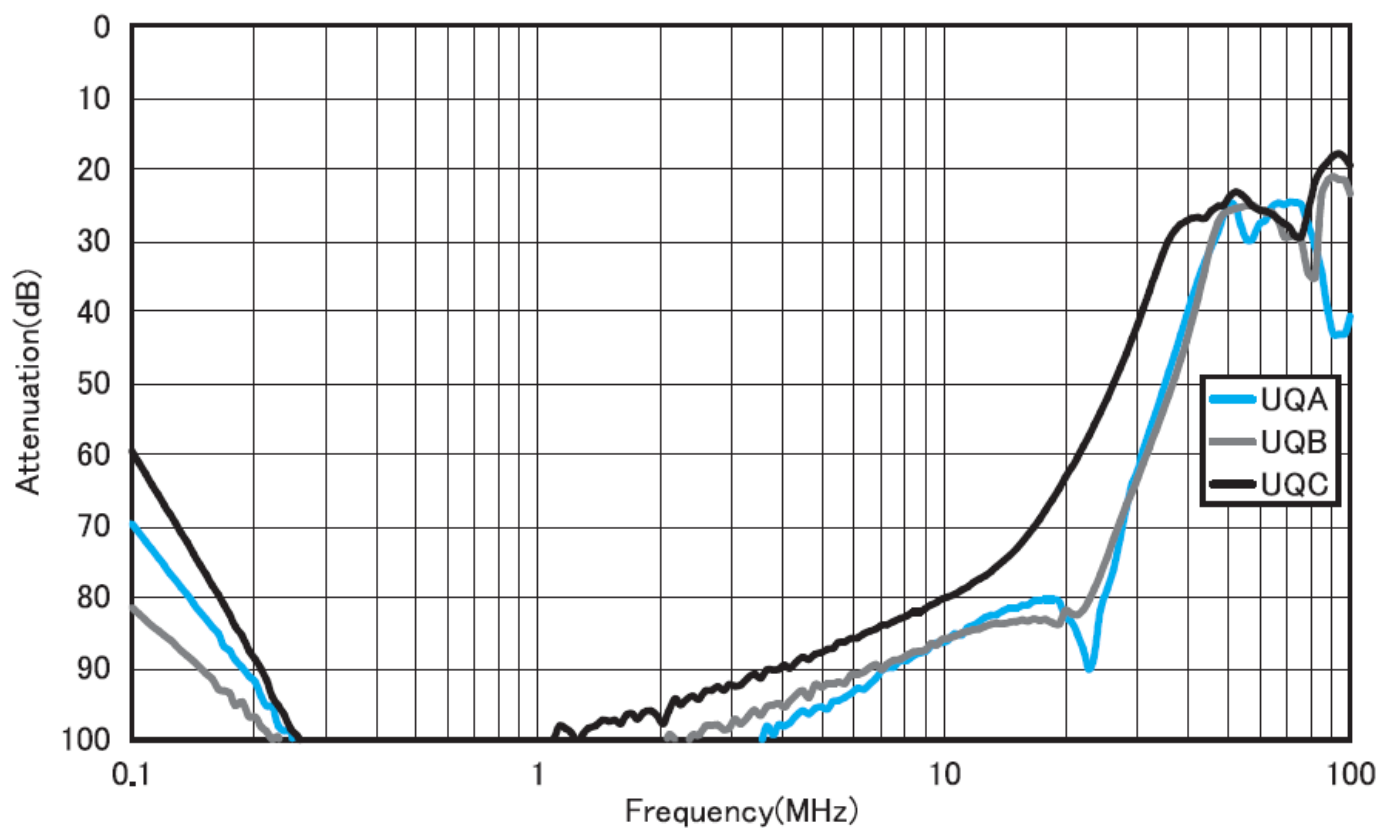

电路图

